

IPC Eagle

**OPERATIONS
MANUAL**

1404

INTRODUCTION / GENERAL WARNINGS

Welcome on board!

We thank you for choosing IPC and congratulate you for purchasing the 1404-1460.

A sweeper especially designed to guarantee safety and concern for the environment.

The innovative design, the robust and trustworthy structure and the recyclable components make 1404-1460. a truly unique machine.

Before using your machine, we advise you to carefully read this handbook.

It is an invaluable guide to the characteristics of your machine and will help you use it correctly.

In particular, it provides precious information concerning safety, integrity and concern for the environment.

INTRODUCTION

This instruction handbook contains guidelines and practical information concerning the use, adjustment and routine maintenance of your new machine.

Your machine has been designed and built to offer the best in terms of performance, comfort and ease-of-use in a variety of different conditions. Before delivery, your machine has been checked at our factory and by our dealer to guarantee that it is handed over to you in perfect working order. To maintain the machine in this condition and ensure problem-free operation, strictly follow the instructions given in the handbook. Before attempting to use the machine, read this handbook and keep it to hand for any future consultation. The words RIGHT and LEFT always refer to the direction in which the machine is travelling. If you have any doubts concerning the machine, do not hesitate to contact your dealer. Dealers will offer you competent personnel, original spare parts and all the equipment you will need. NEVER use the machine without its guards and safety systems. For your safety, make sure all guards and safety systems are closed and correctly mounted before starting the machine.

GENERAL SAFETY RULES

To prevent damage and bodily harm, strictly follow the safety rules below.

Read the safety labels on the machine and do not cover them for any reason whatsoever. Replace them if they are damaged or become unreadable.

- The storage temperature ranges from 0° to + 50°C.
- The optimal working temperature should range from 0° and + 40°C.
- The ambient humidity must range from 30 to 95 %.
- Do not use the machine as means of transport.
- Do not use solvents or similar substances to clean the machine.
- Avoid running the brushes when the machine is still, to prevent damage the floor.
- Do not use the machine to draw up inflammable liquid.
- If fires break out, use a dry-chemical extinguisher. **DO NOT USE WATER.**
- Do not bump against shelves or scaffolding when there is a risk of objects falling over.
- Adapt the speed of the machine to the conditions of adherence.
- Avoid using the machine if its stability is not guaranteed.
- If you notice that the machine is not working properly, make sure this does not depend on failure to carry out the routine maintenance operations. If this is not your case, contact an authorised service centre.
- Always use ORIGINAL spare parts. You can purchase these from a dealer or authorised retailer.
- Disconnect the machine from the mains before carrying out any maintenance operation.
- Do not remove guards that need to be removed with the aid of tools.
- Do not wash the machine with direct jets of pressurised water or with corrosive substances.
- Every 200 hours of work, have the machine checked by an authorised service centre.
- This product is classified as RAEE type special waste and is covered by the requisites of the new environmental protection regulations (2002/96/CE RAEE). It must be disposed of separately from ordinary waste in compliance with current legislation and standards.
- **USE AND STORAGE IN ENVIRONMENTS WHERE THERE IS A RISK OF EXPLOSION IS PROHIBITED**



Special waste. Do not dispose of with ordinary waste.

MODIFICATIONS AND IMPROVEMENTS

Our company policy is based on the continuous improvement of our products. We therefore reserve the right to apply modifications and improvements whenever we believe these are necessary, without having to upgrade the machines previously sold.

SAFETY

Accident-prevention is also your responsibility.

No accident-prevention plan can be effective without the total co-operation of the person directly responsible for machine operation.

Most accidents that occur in a company, during work or transport are caused by failure to observe the basic rules concerning safety.

A careful and prudent user is the best guarantee against accidents and will prove to be much more effective than even the strictest accident-prevention plan.

During work, pay attention to the persons standing in the area to clean, especially children.

SERIAL NUMBER – CE MARKING

Make sure the machine is fitted with a plate featuring the serial number and the CE mark. It is affixed in the position shown in **Fig.1**. If the plate is not in place, contact your retailer immediately.

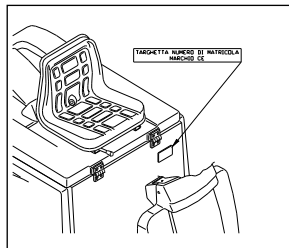

UNPACKING

Unpack your machine with great care, avoiding any manoeuvre that could lead to damage.

Once you have unpacked it, make sure all parts are in a good condition. If you notice any damage, DO NOT use the machine and contact your retailer immediately.

For reasons concerning packaging and transport, some parts and optional items may be supplied disassembled. To assemble them, follow the instructions given in this handbook in the respective sections.

Contents of the package

N°1	Machine
N°1 or 2	Side brush
N°2	Keys for starting
N°1	Use and maintenance handbook
N°1	Declaration of conformity
N°1	Warranty coupon
- - -	Batteries (if purchased)
N°1	Battery connection kit
N°1	Battery charger (if purchased)

The DP version also features the operating instructions of the engine.

If you notice that any of the above are missing, contact your retailer immediately.

NOTE To prevent it from getting lost during transport, the keys have been put inside the envelope containing the technical literature.

Make sure the packaging materials (bags – cartons – pallets – hooks – etc.) are put away, out of the reach of children.

Precautions to take before starting the machine:

To facilitate transport, the side brush (or brushes) is not mounted in its expected working position.

To put it in place, read the – *Preparing a new machine* – section.

THE CONTROLS AND THE CONTROL PANEL

- 1) - Brake engagement pedal
- 2) - Parking brake pedal
- 3) - Flap raising pedal
- 4) - Accelerator pedal
- 5) - Right hand side brush control lever
- 5A) - Left hand side brush control lever
- 6) - Seat adjustment lever

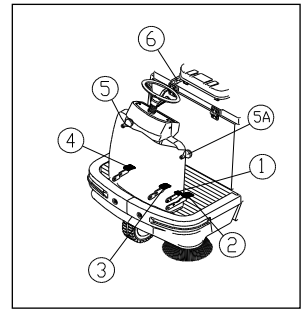

- A) - Selection of displayed data
- B) - Display
- C) - Key and indicator of work programme 1
- D) - Key and indicator of work programme 2
- E) - Key and indicator of work programme 3
- F) - Filter shaker ON button
- G) - ON-OFF button and aspirator motor indicator
- H) - Side brush speed adjustment knob
- I) - Waste bin raising button
- L) - Waste bin lowering button
- M) - Waste bin tipping button
- N) - Button to start/stop the engine (Dual Version)
- O) - Ignition key
- P) - Lever to select the forward or reverse gear
- Q) - Waste bin "full" indicator (**Optional**)
- R) - Fuel Reserve
- S) - Engine Oil Alarm
- T) - Lights ON-OFF
- U) - Horn

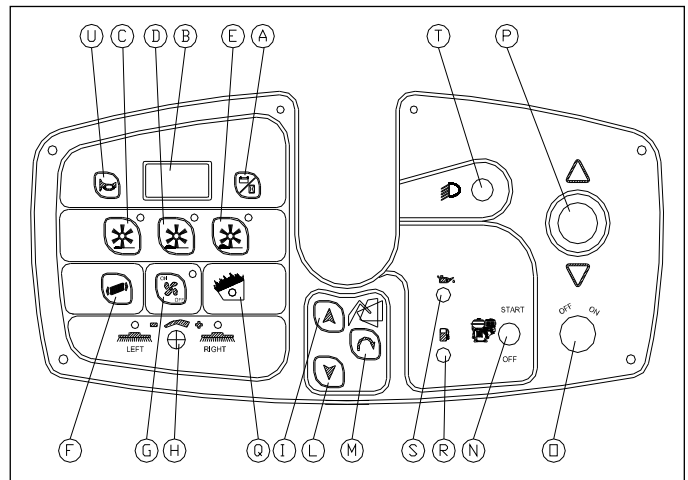

PREPARING THE MACHINE

Either in the petrol or in the DP version, the machine calls for a set of **24 V** batteries.

The machine can be supplied in three options:

- 1 Batteries supplied with the machine, fitted and filled with acid, ready for use.
- 2 Batteries supplied and fitted dry (without the liquid electrolyte).
- 3 Batteries not supplied.

Raise the bonnet carrying the seat by pushing it forward towards the steering wheel and check which option applies to your machine.

If the batteries are fitted, open up one of the vent caps of each battery and check if they are filled with electrolyte.

1 If the batteries are already filled:

Check the level of electrolyte and top up if necessary (use only distilled water).

Recharge (see the MAINTENANCE section and the battery instruction handbook).

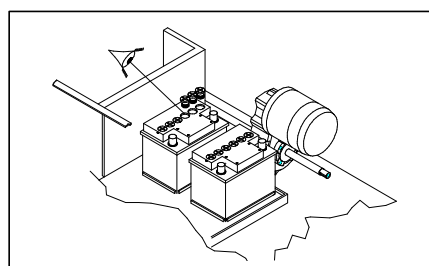
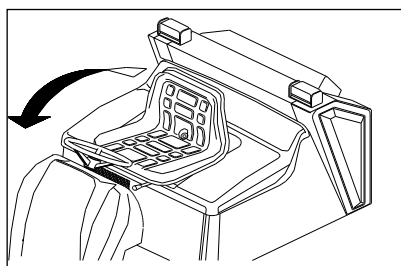

2 If the batteries are supplied without liquid (i.e. dry), they must be filled with sulphuric acid (density from 1.27 to 1.29 kg at 25°C), according to the instructions given in the next paragraph and in the battery handbook:

Filling batteries with acid.

Pay particular attention when you are handling sulphuric acid. This substance is corrosive. If it comes into contact with your skin or eyes, wash with plenty of fresh water and seek medical assistance.

Batteries must be filled in a ventilated area.

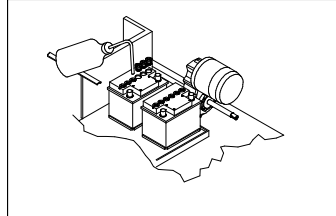
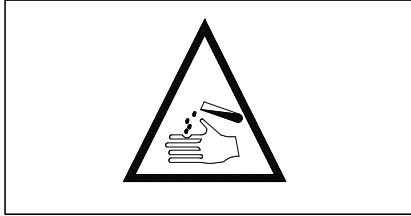

Fill the cells (or single elements) of the batteries with acid. The correct level is indicated in the battery instruction handbooks.

After an hour, top up the cells, if necessary, with more acid.

Let the batteries rest – with the machine stopped – for another hour and then refill, in accordance to the instructions given in the handbook provided with the battery (refer to the “MAINTENANCE” section). During the charging operations, all battery caps must be open.

3 If the machine has been supplied without batteries, these must be purchased and installed accordingly.

Competent battery specialists should preferably be contacted to choose and install the new batteries.

The electrical connection cables supplied with the machine may be used to connect the batteries.

Once the batteries have been installed, connect the battery connector to the machine.

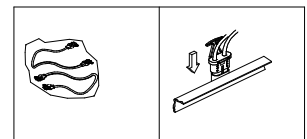
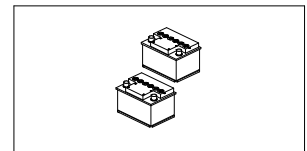

IMPORTANT:

In the battery compartment of the “DP” version equipped with a DIESEL engine, you will find a red electrical cable (X), which must be connected to the battery and in particular to the +12VDC pole. (starter motor power supply +12VDC)

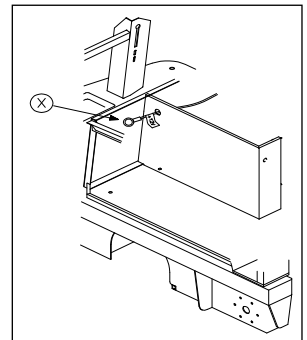

If the machine is in the DP version, it must be filled with lead-free petrol or diesel, depending on the engine. A label indicating the kind of fuel to use is in any case applied near the fuel cap. Check the level of oil in the engine

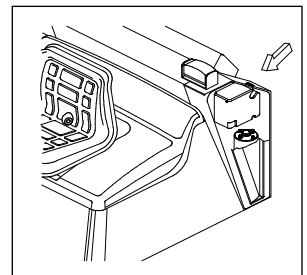

Get onto the machine and adjust the height of the seat to your convenience. The machine is now ready for use.

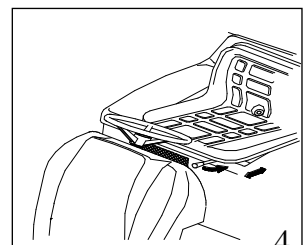

USING THE MACHINE

TURNING ON THE MACHINE

Fit in the ignition key and turn it clockwise. Three zeros will come up on the display for about three seconds, followed by the voltage rating of the battery.

The operator's seat features a safety device that disables traction (forward and reverse) when the operator gets up from his seat.

NOTE: temporary activation of the indicator lights on the console and of the horn is to be considered normal.

IMPORTANT: "DP" version equipped with a DIESEL engine. During operation with an electrical traction motor, the "S" warning light (OIL ALARM) stays lit. This condition can be considered normal.

Let at least three seconds pass after you have turned off the machine, before turning it on again.

Check the state of the batteries on the appropriate display.

The display has two functions: Voltmeter and Hour meter.

The voltmeter features an undervoltage checking function which automatically disables all services, traction excluded, if the battery charge level drops below 20.3V .

In this case, recharge the battery (see the "MAINTENANCE" section and the battery handbook).

If the battery charge level is suitably high, you can start your work.

If the machine features a petrol engine, first start the engine.

STARTING/STOPPING THE PETROL/DIESEL ENGINE

To start the endothermic engine, push toggle switch "N" towards its START position (see switchboard); the toggle switch will flick automatically back to its initial position.

N.B.: if the engine does not start immediately, the maximum activation time of the starter motor must not exceed 5 seconds for a petrol engine and 15 seconds for a diesel engine. These activation intervals can be repeated after a short resting time (approximately 8 – 10 sec.).

To stop the motor, flick toggle switch N to OFF.

IMPORTANT:

the "S" warning light (OIL ALARM) comes on when the ignition is activated.

Once the engine is running, the light should go off. If it does not go off or it comes on when the machine is running, stop and turn off the engine. Check the oil level.

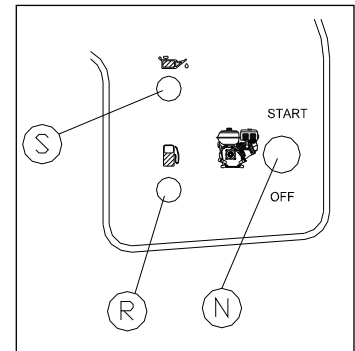

Every time the machine is running with the endothermic engine, make sure the cooling fan is running too. If the alternator overheats, a safety system cuts in to stop the machine.

The number of working hours of the machine can be read on the display under the battery voltage value.

To run the machine, turn on ignition key "O" and select the forward or reverse gear by means of the lever on the instrument board, which is marked "P". Now press the accelerator pedal to start the machine. There is an automatic system for turning the machine on and off on the basis of pre-established work sequences. This function is called "AUTO-POWER-ON/AUTO-POWER-OFF".

By selecting one of the three work programs, namely P1, P2 or P3, you will activate the following functions: centre brush, aspirator, side brushes. The LEDs of the selected brush and suction program will come on.

After a few seconds, the functions are locked and the three LEDs start flashing: the sweeper is in AUTO-POWER-OFF mode.

All functions are automatically reactivated when you press the accelerator pedal: AUTO-POWER-ON.

The machine features an emergency stop button.

By pressing this button (the red warning light comes on), all machine functions, as well as the endothermic engine, will come to a complete and immediate stop. To restart the machine, press the red button and set the machine back into operation.

NOTE: by releasing the accelerator or putting lever P in neutral position, you will disable all functions, with the exception of the engine, within approximately 6 seconds (AUTO POWER OFF).

In this condition, all indicator lights of the selected program and of the suction motor will start flashing.

To reactivate the functions, run the machine forward by pressing the accelerator, without disabling the selected program (AUTO-POWER-ON).

You can select a new program only after disabling the previous one.

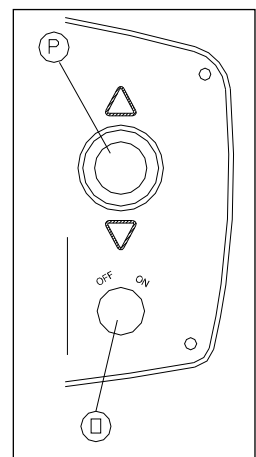

If you are using the machine on wet ground, to protect the paper filters, turn off the suction motor by pressing the ON/OFF key " G " .

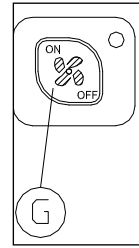

IMPORTANT:

DO NOT RUN THE MACHINE WHILE THE BIN IS RAISED, EXCEPT FOR THE MANOEUVRES NEEDED TO MOVE THE BIN TOWARDS OR AWAY FROM THE WASTE CONTAINER.

Before pushing the machine when it is off or without its batteries, first turn the key to deactivate the electric traction motor. Turn and possibly remove the red key inside the battery compartment, as shown in the figure hereby: this operation will disable the self-braking function of the machine.

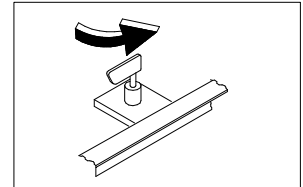

USING THE WORK PROGRAMMES

After turning on the machine and starting the engine, if necessary, choose among the three available programmes, the one best suiting your requirements by pressing one of the three keys.

BUTTON 1 " C " (Light cleaning, indoors, concrete, quartz, smooth floors, etc.)

BUTTON 2 " D " (Medium cleaning, carpet or other surfaces)

BUTTON 3 " E " (Heavy duty cleaning, outdoors, asphalt or rough surfaces with rubble, etc.).

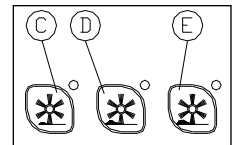

NOTE: the parameters of programmes 1, 2 and 3 are factory set. To modify any of the settings, contact the retailer's service centre.

Lower the left and/or right side brush by pulling out and lowering the relevant knob.

NOTE: the relevant left or right indicator light will come on. To move the brushes back to their **OFF** position, pull up the knobs.

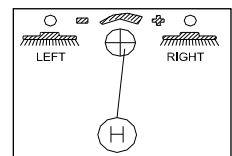

The speed of the side brushes can be changed using the adjustment knob shown in the figure.

FURTHER PERFORMANCES OF THE MACHINE FEATURING AN ENGINE

The version featuring an engine can guarantee the same working efficiency even when the motor is off, for instance when the fuel has run out or when working in closed environments.

The working autonomy, in this case, will depend on the capacity (Amperes/hour) of the batteries installed, on the intensity of the work programme chosen and on the battery charge status.

To guarantee the working life of the batteries, the machine features some safety systems:

1- When the battery voltage drops below 20.3 Volt, all machine functions, with the exception of the traction system, are automatically stopped. When this situation occurs, recharge the batteries or turn on the engine.

2- Protection against excessive battery charging

Being fitted with a current generator featuring an electronic circuit, that acts as voltage regulator, the machine can correctly charge the battery without damaging it with an excessive charge.

In fact, when the battery has been properly charged, it will except no further charging energy.

3- Using the machine with a battery or engine

Further to the tests effected and the results obtained from the evaluation of the energy consumption of our hybrid system, we can affirm that Genius 1404 DP can work autonomously. In other words, the machine does not have to be stopped to recharge the set of batteries (240 Ah). Tests have been made with all three programmes at the user's disposal, namely P1, P2 and P3, on asphalted surfaces and normal slopes, and the sweeper has worked autonomously. However, being the machine designed also for heavy duty working conditions (slopes of over 20%, extremely rough surfaces to clean), the batteries may need to be recharged.

In this case, we recommend the use of an intelligent battery charge with a IUIa charging curve and a final proportional charge, appropriately designed for this kind of machine and of a suitable size for the battery installed.

After you have ended your work, disable the selected programme (1-2-3) and turn off the engine by flicking the toggle switch – “ N “ to OFF.

Before leaving the machine, make sure that the side brushes are raised from the floor, the parking brake is engaged and that the ignition key has been take out of the instrument board.

EMPTYING THE WASTE BIN

This machine can be fitted with visual and acoustic devices signalling when the waste bin is full – see letter “ Q “. When the ‘waste bin full’ indicator light comes on, at the same time the code **CPUU** will start flashing on the display. Empty the bin.

To empty the waste bin, press and hold down the consent button located on the left of the instrument board and select the requested function.

1- Press the button on the console - letter “ I “and hold it down until the requested emptying height has been reached.

2- Move to the waste container.

3- Press the button on the console - letter “ M “ and hold it down until the bin has been tipped to enable all its contents to fall out. As soon as you release this button, the bin will automatically return to its horizontal position.

N.B.: the machine features a safety device that prevents the bin from rotating unless it has reached a safe distance from the machine. In fact, no damage will be caused if the operator presses button “ M “ by mistake, i.e. before the bin has reached its pre-established height.

4- Move away from the waste container and press the butto, which is marked “ L “, so that the bin can gain its initial position (lowered).

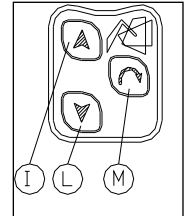

CLEANING AND SERVICING THE FILTER

The filter is a very important component of the machine and essential for correct operation. Proper filter maintenance will allow you to obtain the best performance from your machine. The filter can be cleaned in any of the following three ways:

1) by means of the automatic cleaning system

As you select a work programme, the machine will automatically adopt an automatic cleaning cycle for the two filter shakers and the filter, which is based on a pre-established series of time settings.

2) by means of an electric filter shaker that is manually started

Just a simple command is needed to keep the filter in perfect working order: press the button marked “ F “and hold it down for a few seconds. Repeat this operation 4 or 5 times.

Remember that the cleaner the filter, the better the results of your cleaning session. It is recommended to carry this operation out at the end of each work cycle.

NOTE: dusty environments

If you are using the machine in a dusty environment (e.g. sawmills – warehouses where haulage vehicles pass, etc.), it is a good idea to use the filter shaker more frequently.

3) by manually cleaning the filter

If operating the filter shaker is not enough to keep the filter clean - and in any case every 20 hours of work - clean the filter manually. Before carrying out any kind of intervention on the machine, make sure it is turned off and that all functions are deactivated. To obtain this condition, turn the switch marked “ O “ to OFF.

1° Remove the rear machine panel

2° Take the two filters out of their seat by turning the 4 retainer handles.

3° Blow compressed air (at a pressure of 6 bar at the most).

4° Refit the filters and the rear panel.

FITTING AND REPLACING THE SIDE BRUSHES

To facilitate transport, the side brush (or brushes) is not fitted in its expected working position.
To fit the brush in its correct working position, proceed as follows:

- 1- Pull up the brush knob.
- 2- Loosen the screw on the shaft of the side brush motor.
- 3- Remove the key protection.
- 4- Place the brush with its flange on the shaft.
- 5- Tighten the fixing screw.

To replace worn side brushes, carry out the operations listed above.

REPLACING LIGHT BULBS

To replace the front light bulb:
Remove the front cover by loosening the fixing screws.
Replace the bulb, making sure that the new bulb has suitable electrical features.
Refit the front cover.

REPLACING THE CENTRE BRUSH

Caution: this operation must be carried out with the machine off and the key removed.

This machine features a system for automatically adjusting the pressure exerted and compensating for wear.
The code "WORN BRUSHES" will come up on the display to indicate that the centre brush needs to be replaced.

To replace the centre brush, proceed as follows:

Open up the door on the left hand side of the machine by loosening the knob, as shown in the figure.

Unscrew and remove the three knobs that secure the cover of the brush compartment in place.

Remove the cover of the brush compartment.

Remove the worn brush.

Remove the adapter of the brush stem and fit it onto the new brush. Maintain the same inclination of the bristles.

(See the next figure).

Refit the adapter and mount the new brush. Make sure the adapter is inserted into the hub.

Refit the cover of the brush compartment and tighten the knobs by following the disassembly instructions in reverse order.

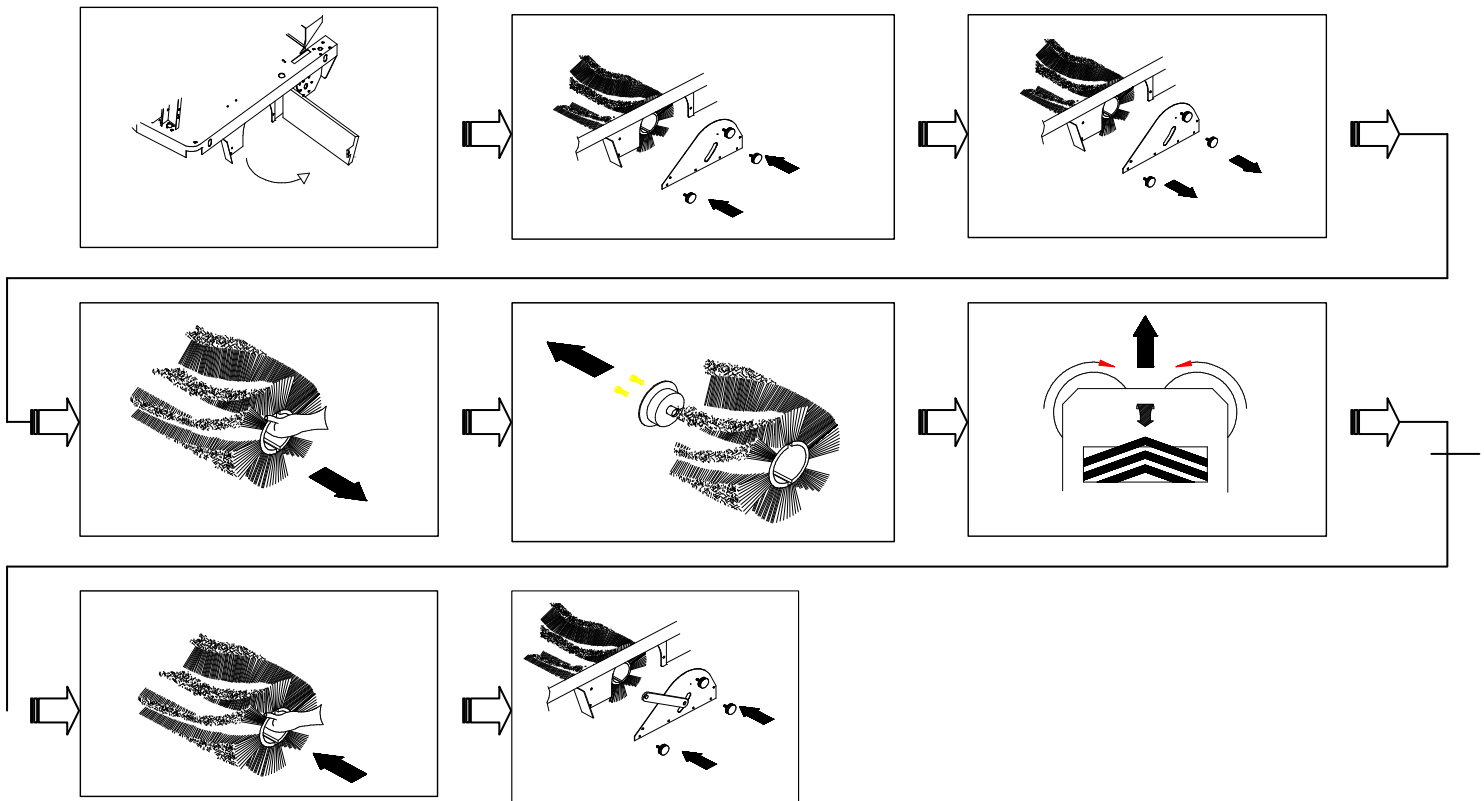

MAINTENANCE,CHECKING AND RECHARGING THE BATTERY

Check the level of electrolyte inside the batteries regularly.

The battery compartment is under the operator's seat. Raise the bonnet and open the caps on the cells. If necessary, top up with distilled water.

The level of electrolyte is indicated in the battery instruction handbook.

IMPORTANT: check the battery level every 100 hours.

After you have filled the battery, close the cells with their caps and clean the top surface.

Pay the utmost attention when you are handling the battery liquid, as it is corrosive. In the event of contact with your skin or eyes, wash with plenty of fresh water and seek medical assistance.

Whenever necessary, charge the battery according to the following instructions:

- Turn the machine off with the main key.
- Raise the bonnet.
- Disconnect the machine's battery connector.
- The battery must be recharged in a sufficiently ventilated area
- Open up all the caps of the battery cells.
- Connect the battery connector to the battery charger.
- Connect the battery charger to the mains (the mains voltage and frequency ratings must correspond to those of the battery charger).
- After charging, disconnect the battery from the charger and hook it up to the machine.
- Put the caps back on and clean the top surface of the battery.

ADJUSTING THE BRAKE

If the service brake or parking brake is not effective enough, it can be adjusted by acting on the front wheel. Loosen locknut " A " by turning screw " B ", then tighten " A " again.

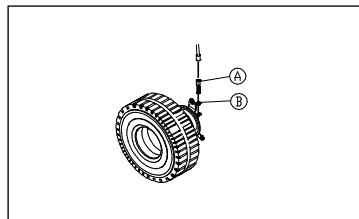

ENGINE MAINTENANCE

Take into account that it is necessary to carefully read the use and maintenance handbook of the engine. However, here is some practical advice:

Check the level of oil in the engine at least once a month, using the dipstick. Top up using the oil indicated on the instruction handbook.

NOTE: the engine oil must be replaced after the first 20 hours of work or in any case within a month.

It is then sufficient to replace it every 100 hours of work or within 8 months.

To replace the oil in the engine, proceed as follows:

- a) Remove the right hand side casing of the machine by loosening the fixing screws.
- b) Gain access to the oil drainage pipe.
- c) Unscrew the dipstick.
- d) Take the cap off the drainage pipe and let the exhaust oil drain out.

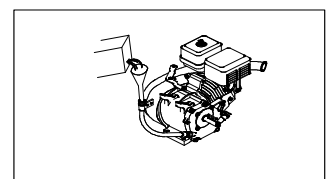
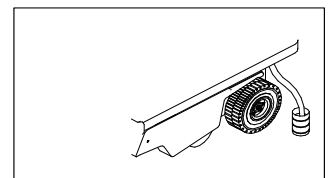
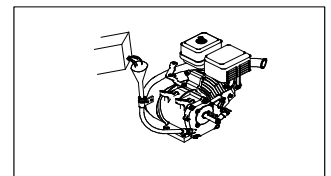

NOTE: oil should preferably be drained when the engine is hot.

Pour in new oil of the type and in the quantity indicated on the use and maintenance manual of the engine. Use only SAE 15/49 multigrade oil which ensures effective lubrication at an ambient temperature ranging from -15°C to over 40°C .

AIR FILTER OF THE ENGINE

Check the state of the engine's air filter regularly.
 If necessary, wash the sponge (pre-filter) with water and soap or a standard household detergent.
 Rinse and dry.
 When necessary, replace the air filter of the engine.
 Refit the filter and cover.
 Clean the fuel filter regularly.
 Before carrying out any of the above operations, consult the use and maintenance handbook of the engine.

"CHANGE OIL" ALARM CODE

The "CHANGE OIL" error code informs users, every 100 hours of work, that the oil of the endothermic engine needs to be replaced (this function is active in D.P. versions only). Press the key on the left hand side of the display twice and the partial hour meter of the endothermic engine will appear. This is a four-digit display: the first digit on the left (0-9 range) and the three remaining digits display the actual hours of work of the engine. When the engine has been running for 100 hours, the message "CHANGE OIL" starts flashing on the display. This means that the oil must be replaced (see the maintenance chapter in the engine handbook). After replacing the oil, users must reset the hour meter (see the maintenance chapter in the engine handbook), as described below:

By pressing key " A " twice, you will display the hours and minutes of operation of the endothermic engine (OIL HOUR METER).

To reset the OIL HOUR METER, hold down key " A " for at least 5 seconds when the "OIL HOUR METER" page is displayed.

The first digit on the display increases by one unit, so that the operator will know how many times oil has been replaced.

N.B.: if the oil is not replaced, the buzzer will go off five times every time the machine is turned on and the message "CHANGE OIL" will start flashing on the display. The "CHANGE THE OIL" message disappears when the key on the left hand side of the display is pressed and the voltmeter comes up on the display.

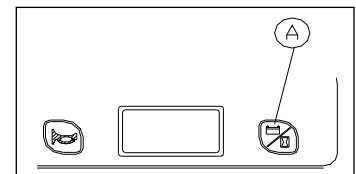

USER PROGRAMMING

To enter USER PROGRAMMING, hold the display button down for 5" as the battery voltage - with no active load - is being displayed.

You can program the following, in the order indicated:

1. LANGUAGE: select using buttons P1 and P3. Give the display button a short press to memorise your setting and open the next page.
Default = ITALIAN.
2. PROGRAM 1 PRESSURE XXX : program 1. Operating pressure of brushes. The displayed parameter can be reduced by pressing P1 or increased by pressing P3. Parameter X can range from 0 to 100. Give the display button a short press to memorise your setting and open the next page.
Default = 020.
3. PROGRAM 1 SPEED XXX : program 1. Operating speed The displayed parameter can be reduced by pressing P1 or increased by pressing P3. Parameter X can range from 010 to 100. The correspondence between the set parameter and PWM is:

010 = 25 %
020 = 34 %
030 = 43 %
040 = 50 %
050 = 60 %
060 = 68 %
070 = 77 %
080 = 85 %
090 = 92 %
100 = 100 %

Give the display button a short press to memorise your setting and open the next page.

4. PROGRAM 2 PRESSURE XXX. Identical to program 1. Pressure XXX relates only to program 2.
Default = 040.
5. PROGRAM 2 SPEED XXX. Identical to program 1. Speed XXX relates only to program 2.
Default = 070.
6. PROGRAM 3 PRESSURE XXX. Identical to program 1. Pressure XXX relates only to program 3.
Default = 070.
7. PROGRAM 3 SPEED XXX. Identical to program 1. Speed XXX relates only to program 3.
Default = 050.
8. POWER OFF YES/NO: enable POWER-OFF. The parameter can be changed with button P1 or P3.
Give the display button a short press to memorise your setting and open the next page.
Default = YES.
9. BRUSH UPSTROKE YES/NO: brush rises during reverse movements. The parameter can be changed with button P1 or P3.
Default = YES.
10. FILTER SHAKER. Filter shaker activation mode. The parameter can be changed with button P1 or P3. Possible settings are:

MANUAL
SF 0 automatic with traction activated
SF 1 automatic with traction deactivated
60" AUTO
120" AUTO
180" AUTO
240" AUTO
300" AUTO
360" AUTO
420" AUTO
480" AUTO
600" AUTO

Give the display button a short press to memorise your setting and open the next page.

Default = 1.

SUMMARY TABLE

MAINTENANCE OF THE BATTERY VERSION

IMPORTANT: these operations must be carried out with the machine off and the key removed.

All routine and corrective maintenance operations must be effected by competent personnel or at an authorised service centre.

NOTE: the life of the battery strictly relates to regular periodic maintenance (checking the level and density of the electrolyte).

If the machine has not been used for a long time (for instance 4-6 weeks), it is in any case necessary to recharge the batteries to guarantee that the voltage level never drops below the threshold value of 20.3 V.

If not used, batteries tend to lose their charge.

- A : Upon delivery
- B : Every 30 hours
- C : Every 50 hours
- D : Every 100 hours
- E : Every 400 hours

CHECK	A	B	C	D	E
Battery liquid and voltage levels	*	* (or every 2 weeks)			
Check the brushes (or charcoal) of all electric motors and replace if worn					*
Tightness of the belts	*			*	
Brake adjustment	*			*	
Filter shaker					
Tightness of the nuts and screws					*
State of the side brush			*		
Clean the panel filter			*		
Tightness of the bin, filter, flap gaskets	*		*		
Grease the steering system chains				*	

SUMMARY TABLE

MAINTENANCE OF THE DUAL POWER - PETROL /DIESEL VERSION

IMPORTANT: these operations must be carried out with the machine off and the key removed.

All routine and corrective maintenance operations must be effected by competent personnel or at an authorised service centre. As far as maintenance work on the engine is concerned, refer to the relevant handbook.

NOTE: the life of the battery strictly relates to regular periodic maintenance (checking the level and density of the electrolyte).

If the machine has not been used for a long time (for instance 4-6 weeks), it is in any case necessary to recharge the batteries to guarantee that the voltage level never drops below the threshold value of 20.3 V.

If not used, batteries tend to lose their charge.

- A : Upon delivery
- B : Twice a week
- C : Every week
- D : Every 20 hours
- E : Every 50 hours
- F : Every 100 hours
- G : Every 150 hours
- H : Every 300 hours
- I : Every 400 hours

CONTROLLARE	A	B	C	D	E	F	G	H	I
Battery liquid and voltage levels	*		*						
Clean the engine air filter					*				
Clean the panel filter					*				
Oil and engine	*	*							
Replace the engine oil (PETROL VERSION)				1st time		*			
Check the brushes (or charcoal)									*
Tightness of the belts	*					*			
Brake adjustment	*					*			
Filter shaker									
Tightness of the nuts and screws									*
State of the side brush					*				
Tightness of the bin, filter, flap gaskets	*				*				
Grease the steering system chains						*			
Replace the engine oil (DIESEL VERSION)					1st time	*			
Replace the oil filter (DIESEL VERSION)					1st time			*	

SAFETY AND TROUBLESHOOTING

The machine features some safety functions that have been described in the chapters concerning the use of both versions (with or without an engine): for instance, the system for stopping all functions to prevent the battery from running out or the possibility of turning the red key to disable the self-braking function in the event that the machine has to be pushed.

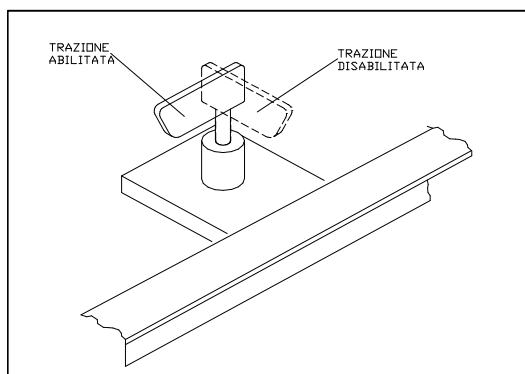

SECURITY CODE	FAULT DESCRIPTION	REMEDY
TRACTION PROBLEM	This alarm can be reset only by removing the key. All functions are disabled and remote switch is disconnected.	<ol style="list-style-type: none"> 1 Check traction engine charcoal and cables between engine and electronic card. 2 If the charcoal and the connection cables are regular, request replacement of electronic power card.
PAUSE MOTOR	Engine thermal overload (machine shutdown due to traction engine overload).	<ol style="list-style-type: none"> 1 Check traction engine power intake with wheel raised: must be less than 30A . 2 Check operation of temperature sensor in traction engine (it is closed when cold).
TRACTION PAUSE	Thermal overload of traction card heat sink greater than 85° (traction stop).	If ambient temperature is not particularly high, carry out the same test on the traction engine if power intake is within set range. Leave engine to cool for at least 30 minutes.
ACCELERATOR KEY	Accelerator pedal kept pressed by mistake during key-actuated startup of machine.	<ol style="list-style-type: none"> 1 Release accelerator before turning the key. 2 If the accelerator key sequence code remains, check the gauge and the microswitch underneath the accelerator pedal.
WIRE ACCELE.	Pedal gauge cable broken.	Check cables of the gauge located underneath the accelerator pedal. .
CHANGE OIL	Is actuated after 99 hours of operation of engine.	To reset the alarm, after changing the oil, press the display switch for 5" whilst the oil meter is displayed.
BRUSH CURRENT	If current greater than 50A is absorbed continuously for 10", the function will be inhibited.	Error can be reset only by switching off the machine or actuating the new preset programme.
WORN BRUSHES	If the jack remains below the brushes for more than 10" consecutively with lower microswitch open. Only message.	Can be reset only by switching off machine.
BATTERY RESERVE	If voltage read on KEY line falls below 21.3V (ACID) or 21.7V(GEL) for 3" consecutively: Only message.	Reset if voltage returns to 24.0V for 3" consecutively.

ENGLISH

DOWN BATTERY	If voltage read on KEY line falls below 20.3V (ACID) or 20.7V(GEL) for 3" consecutively.	Reset if voltage returns to 24.0V for 3" consecutively. All functions except traction are inhibited. Recharge the battery.
BATTERY FLAT	If voltage read on KEY line falls below 18.0V (ACID) or 18.3V(GEL) for 3" consecutively.	Reset if voltage returns to 21.3V for 3" consecutively. All functions and traction are inhibited. Recharge the battery.