

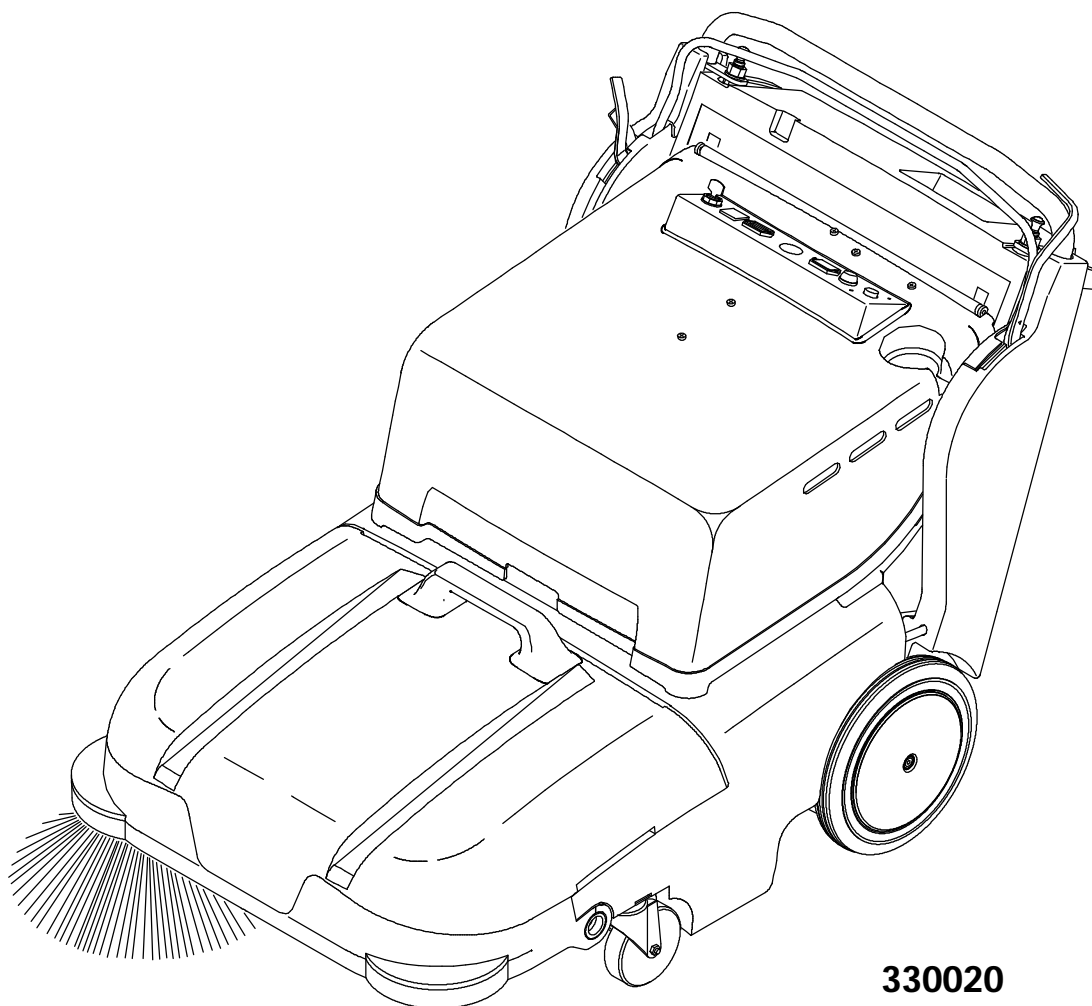

6080E

Operator Manual



330020

Rev. 04

é B! 5βê



This manual is furnished with each new TENNANT Model 6080E sweeper. It provides necessary operating and preventive maintenance instructions. Read this manual completely and understand the machine before operating or servicing it.

This machine will provide excellent service. However, the best results will be obtained at minimum costs if:

- The machine is operated with reasonable care.
- The machine is maintained regularly - per the maintenance instructions provided.
- The machine is maintained with TENNANT supplied or approved parts.

Manual Number - 330020

Revision: 04

Published: 01-00

CONTENTS

	Page		Page
SAFETY PRECAUTIONS	3	VACUUM INLET PLATE	37
OPERATION	5	CLEANING THE PANEL FILTER	38
OPERATOR RESPONSIBILITY	5	BRUSHES	39
MACHINE COMPONENTS	6	MAIN BRUSH	39
SYMBOL DEFINITIONS	7	REPLACING THE MAIN BRUSH ..	39
CONTROLS AND INSTRUMENTS	8	CHECKING AND ADJUSTING MAIN	
OPERATION OF CONTROLS	9	BRUSH PATTERN	41
DIRECTIONAL CONTROL LEVER ...	9	ROTATING THE MAIN BRUSH ...	42
CLUTCH HANDLE	11	SIDE BRUSH(ES)	43
MAIN BRUSH LEVER	11	REPLACING THE SIDE	
SIDE BRUSH LEVER	12	BRUSH(ES)	43
STEERING BAR	12	ELECTRIC MOTORS	43
STEERING BAR ADJUSTMENT		BELTS AND CHAINS	44
KNOBS	12	VACUUM FAN BELT	44
KEY SWITCH	13	MAIN BRUSH BELT	44
HOURMETER	13	STATIC DRAG CHAIN	44
BATTERY DISCHARGE INDICATOR .	13	CLUTCH CABLE	44
POWER KILL SWITCH		TIRES	45
(OPTION)	14	PUSHING AND TRANSPORTING THE	
CIRCUIT BREAKERS	14	MACHINE	45
FILTER SHAKER SWITCH	15	STORING MACHINE	45
THERMO SENTRY™	15	SPECIFICATIONS	46
VACUUM WAND	15	GENERAL MACHINE	
HOW THE MACHINE WORKS	16	DIMENSIONS/CAPACITIES	46
PRE-OPERATION CHECKLIST	16	GENERAL MACHINE PERFORMANCE ..	46
STARTING THE MACHINE	17	POWER TYPE	47
SWEEPING AND BRUSH		TIRES	47
INFORMATION	18	MACHINE DIMENSIONS	48
SWEEPING	19	INDEX	49
SWEEPING CARPET	20		
STOP SWEEPING	21		
EMPTYING THE DEBRIS HOPPER	23		
STANDARD HOPPER	23		
HOPPER DUMP ASSIST			
HANDLE (OPTION)	24		
REPLACING THE BAG FILTER	25		
CLEANING THE FILTER			
COMPARTMENT	26		
POST-OPERATION CHECKLIST	27		
OPERATION ON INCLINES	27		
OPTIONS	28		
WIDE TRACK TIRES AND HEAVY DUTY			
CASTERS	28		
MACHINE TROUBLESHOOTING	29		
MAINTENANCE	31		
MAINTENANCE CHART	31		
BATTERIES	32		
CHARGING THE BATTERIES	33		
LUBRICATION			
HEAVY DUTY CASTERS (OPTION) ..	35		
SKIRTS AND SEALS	36		
MAIN BRUSH SKIRTS	36		
HOPPER DUST SEAL	36		
REAR SKIRT	36		
HOPPER LIP SKIRT	37		
FILTER COMPARTMENT			
DOOR SEAL	37		

SAFETY PRECAUTIONS

The following symbols are used throughout this manual as indicated in their description:



WARNING: To warn of hazards or unsafe practices that could result in severe personal injury or death.

FOR SAFETY: To identify actions that must be followed for safe operation of equipment.

The machine is suited to sweep disposable debris. Do not use the machine other than described in this Operator Manual. The machine is not designed for use on public roads.

The following information signals potentially dangerous conditions to the operator or equipment:

FOR SAFETY:

1. **Do not operate machine:**
 - Unless trained and authorized.
 - Unless operation manual is read and understood.
 - In flammable or explosive areas unless designed for use in those areas.
2. **When starting machine:**
 - Keep directional lever in Park position.
3. **When using machine:**
 - Go slowly on inclines and slippery surfaces.
 - Use care when reversing machine.
 - Do not carry riders on machine.
 - Always follow safety and traffic rules.
 - Report machine damage or faulty operation immediately.
4. **Before leaving or servicing machine:**
 - Stop on level surface.
 - Move directional lever into Park position.
 - Turn off machine and remove key.

5. **When servicing machine:**
 - Avoid moving parts. Do not wear loose jackets, shirts, or sleeves when working on machine.
 - Wear eye and ear protection if using pressurized air or water.
 - Disconnect battery connections before working on machine.
 - Avoid contact with battery acid.
 - Use Tennant supplied or equivalent replacement parts.



WARNING: Heavy hopper. Get help to handle.



WARNING: Brush throws debris. Stop motor before lifting hopper.



WARNING: Moving belt and fan. Keep away.



WARNING: Batteries emit hydrogen gas. Explosion or fire can result. Keep sparks and open flame away. Keep covers open when charging.

SAFETY PRECAUTIONS

The following safety labels are mounted on the machine in the locations indicated. If these or any labels become damaged or illegible, install a new label in its place.

BATTERY CHARGING LABEL - LOCATED ON THE UNDERSIDE OF THE BATTERY COMPARTMENT COVER

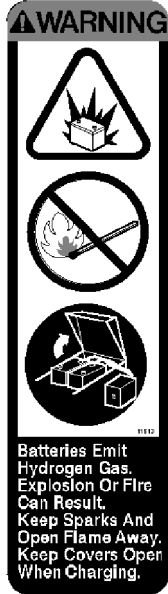

FOR SAFETY LABEL - LOCATED ON THE CONTROL PANEL

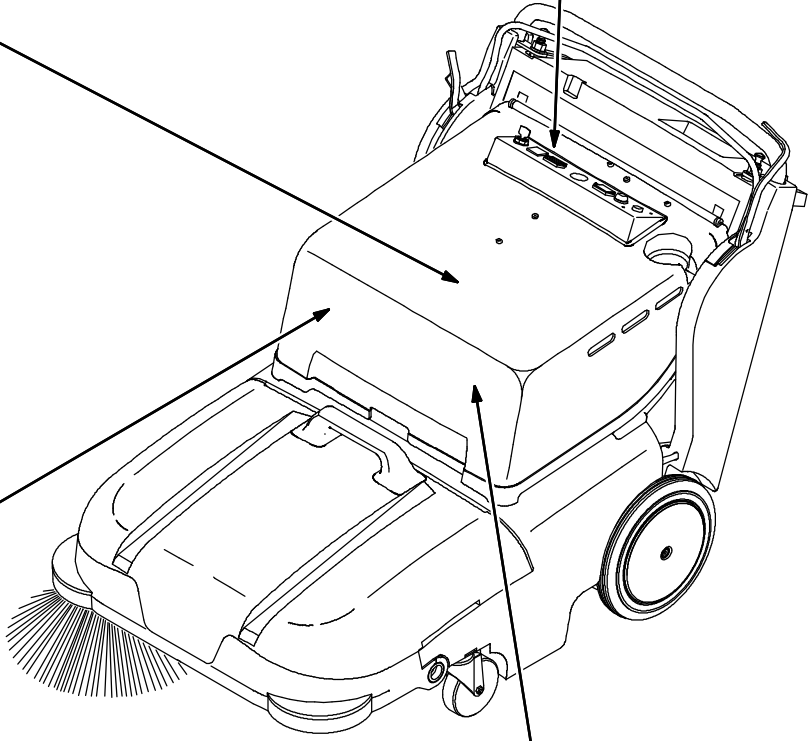
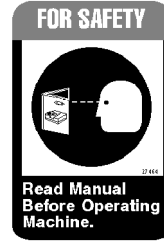

BACK STRAIN LABEL - LOCATED ON THE MOTOR COMPARTMENT COVER

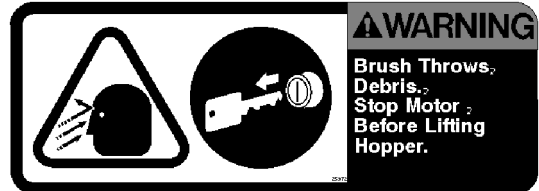

FLYING DEBRIS WARNING LABEL - LOCATED ON THE MOTOR COMPARTMENT COVER

350842

OPERATION

OPERATOR RESPONSIBILITY

- The operator's responsibility is to take care of the daily maintenance and checkups of the machine to keep it in good working condition. The operator must inform the service mechanic or supervisor when the maintenance intervals are required as stated in the *MAINTENANCE* section of this manual.
- Read this manual carefully before operating the machine. View the operation video supplied with the machine.

FOR SAFETY: Do not operate machine, unless operation manual is read and understood.

- Check the machine for shipping damage. Check to make sure the machine is complete per shipping instructions.
- Keep your machine regularly maintained by following the maintenance information in this manual. We recommend taking advantage of a regularly scheduled service contract from your Tennant representative.
- Order parts and supplies directly from your authorized Tennant representative. Use the parts manual provided when ordering parts.
- After the first 50 hours of operation, follow the recommended procedures stated in the *MAINTENANCE CHART*.

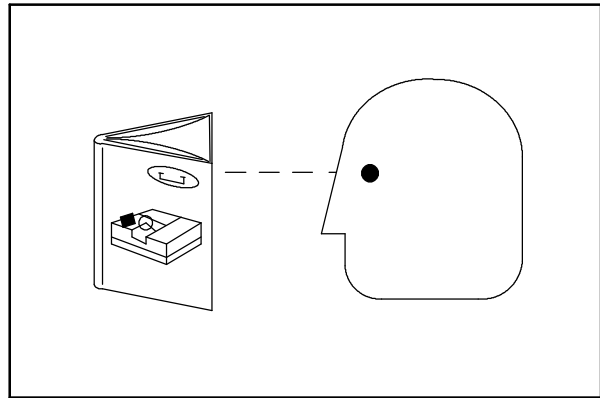

07324

OPERATION

MACHINE COMPONENTS

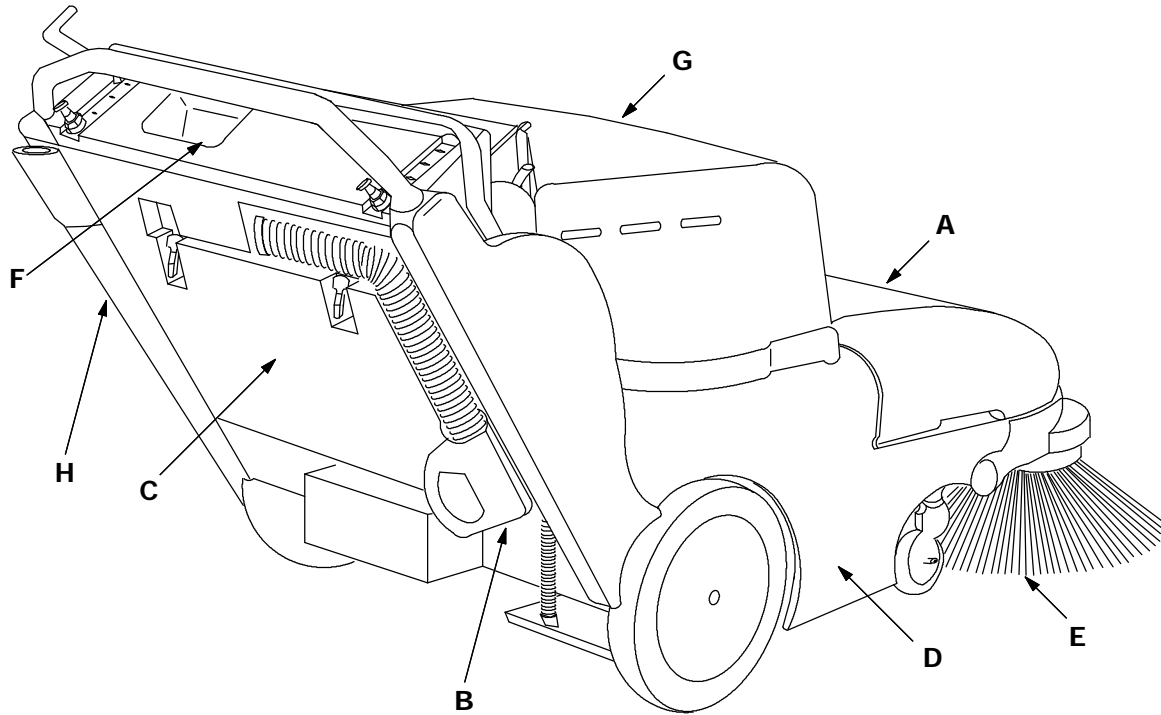

- A. Debris hopper
- B. Vacuum wand (option)
- C. Filter compartment
- D. Main brush
- E. Side brush
- F. Accessory bin
- G. Battery compartment
- H. Vac wand extension (option)

350660

SYMBOL DEFINITIONS

These symbols identify controls, displays, and features on the machine:



Start



Filter shaker switch



Side brush(es) down and on



Side brush(es) up and off



Main brush down pressure



Main brush down and on



Main brush up and off



Battery discharge indicator



Circuit breaker #1



Circuit breaker #2

CONTROLS AND INSTRUMENTS

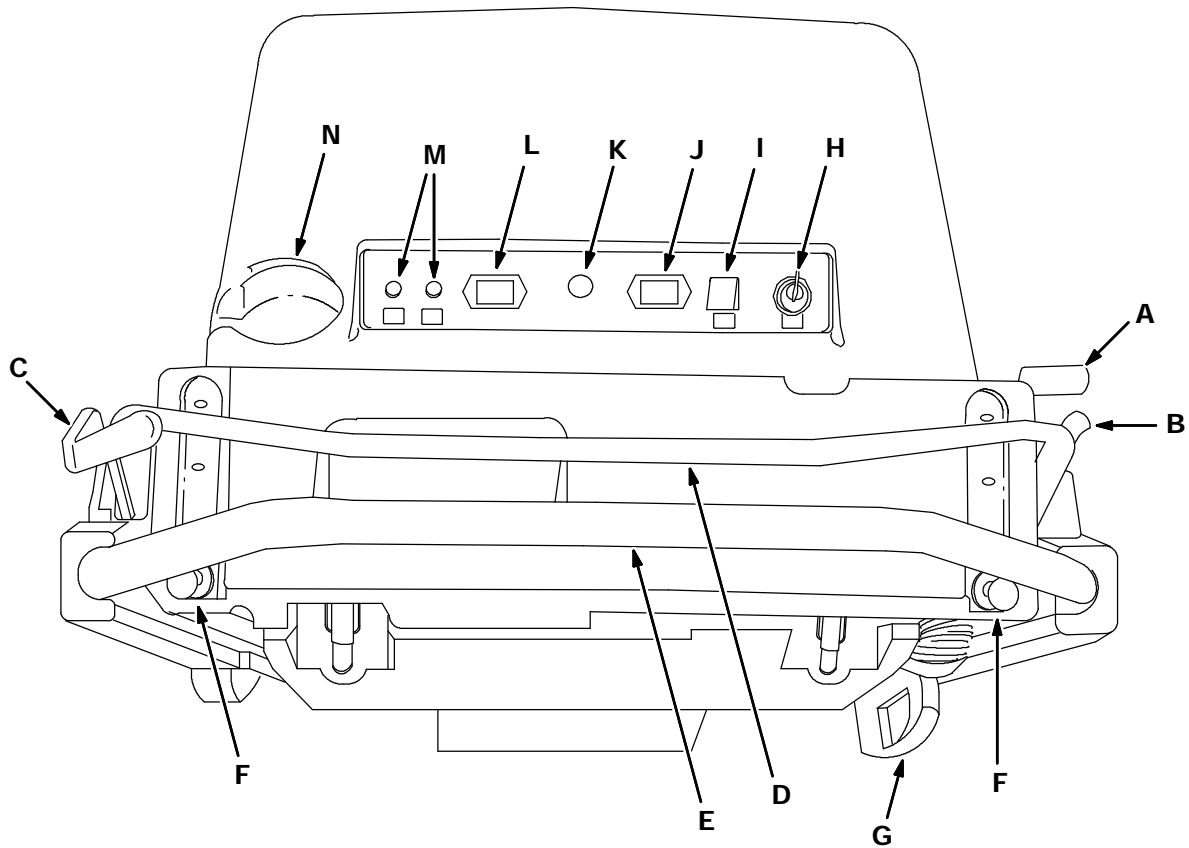

- A. Main brush lever
- B. Side brush lever
- C. Directional control lever
- D. Clutch handle
- E. Steering bar
- F. Steering bar adjustment knobs.
- G. Vacuum wand (option)
- H. Key switch
- I. Filter shaker switch
- J. Battery discharge indicator
- K. Battery disconnect button (option)
- L. Hourmeter
- M. Circuit breakers
- N. Beverage holder

350658

OPERATION OF CONTROLS

DIRECTIONAL CONTROL LEVER

The directional control lever controls the machine's speed and direction of travel. The machine has three forward speeds: second, first, and third; one reverse speed; as well as neutral and park settings.

The speed selection pattern is designed to allow the operator to move the control lever quickly between second speed and reverse. The neutral setting is located midway between these positions. Since reverse and second speed will be used most often for routine sweeping, the area between these positions is called the working range. The directional control lever positions are labeled near the base of the directional control lever in the following order:

PARK: Pull the directional control lever toward you as far as it will go. The directional control lever should always be in the PARK position when starting, stopping, or leaving the machine unattended while the machine is powered on.

REVERSE: Move the directional control lever to the left, then one position forward from the PARK position. The machine will move backward when the clutch handle is squeezed.

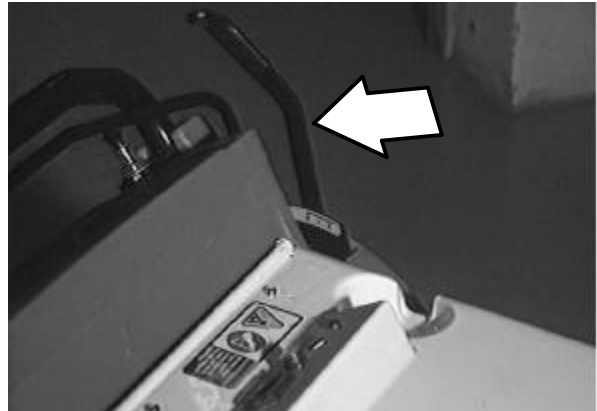

OPERATION

NEUTRAL: Push the directional control lever halfway between the REVERSE position and the SECOND SPEED position. The machine will not move forward when the clutch handle is squeezed while in NEUTRAL. Do not leave the machine powered on in NEUTRAL while the machine is unattended.

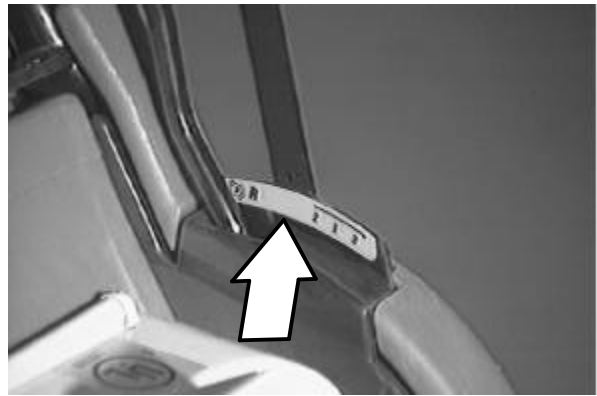

SECOND SPEED: Push the directional control lever one position forward from the NEUTRAL position. The machine will move forward when the clutch handle is squeezed. Use SECOND SPEED for normal sweeping.

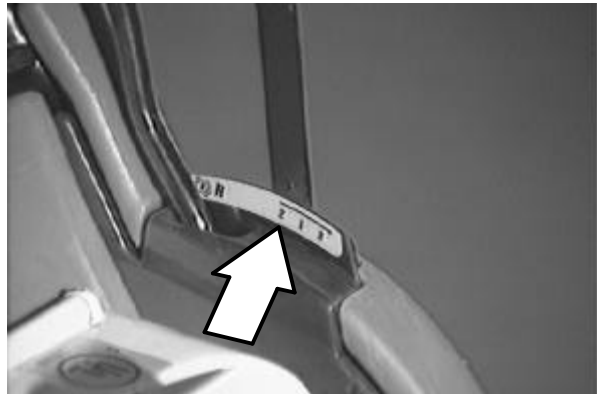

FIRST SPEED: Move the directional control lever to the left, then one position forward from the SECOND SPEED position. The machine will move forward when the clutch handle is squeezed. Use FIRST SPEED on inclines and slippery surfaces.

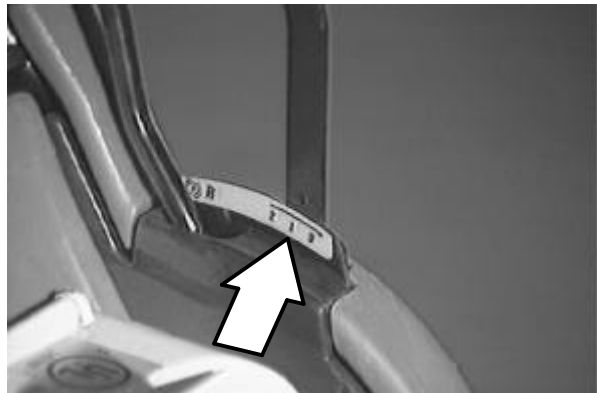

THIRD SPEED: Move the directional control lever to the left, then forward as far as it will go. The machine will move forward when the clutch handle is squeezed. Use THIRD SPEED for sweeping in wide open areas or for transport to the dumping area when the hopper is full.

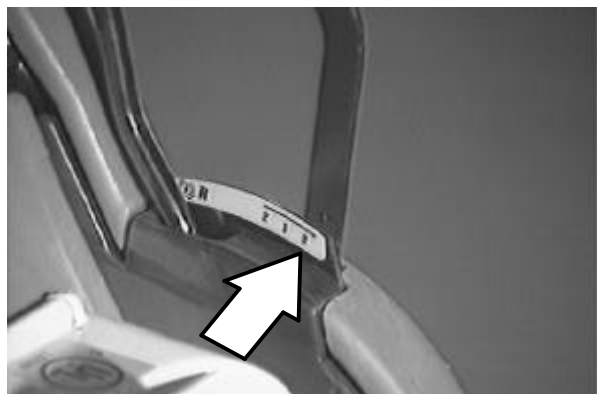

CLUTCH HANDLE

The clutch handle engages the machine's propelling system when the direction control lever is positioned in a forward or reverse position. The farther the clutch handle is squeezed toward the steering bar, the faster the machine will travel, up to its maximum in the selected position.



Braking: To stop the machine at any time, regardless of direction of travel, release the clutch handle. The machine will immediately slow down, then stop completely.



MAIN BRUSH LEVER

The main brush lever raises and lowers the main brush. The main brush rotates automatically when the machine is powered on. The main brush rotates whether in the raised or lowered position.

Main brush down: Move the main brush lever to the left, out of the raised position, then allow it to fall forward into the sweeping position.

Main brush up: Move the main brush lever backward, then to the right to raise and set the main brush in the raised position.

NOTE: For sweeping carpet: The brush pressure pin included in the carpet sweeping kit (option) must be installed to control brush pressure. See SWEEPING CARPET.



OPERATION

SIDE BRUSH LEVER

The side brush lever raises and lowers the side brush. The side brush will rotate automatically when lowered. The side brush does not rotate when raised.

Side brush down and on: Move the side brush lever to the right, out the the raised position, then forward to the desired brush down pressure setting.

Side brush up and off: Move the side brush lever backward, then to the left to raise and set the side brush in the raised position.



STEERING BAR

Use the steering bar to steer the machine.



STEERING BAR ADJUSTMENT KNOBS

The steering bar adjustment knobs allow you to move and lock the steering bar into a position that is most comfortable for you. Pull both adjustment knobs out at once to raise or lower the steering bar.

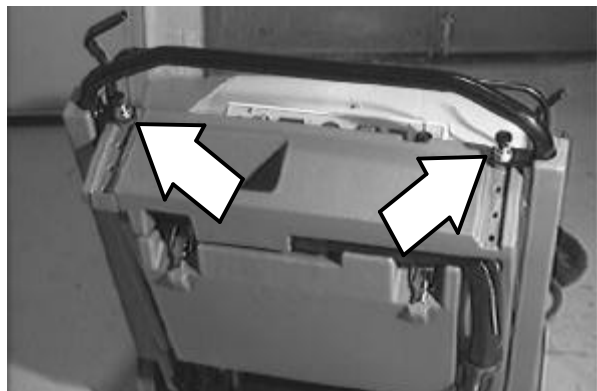

KEY SWITCH

The ignition switch turns the power to the machine on and off using a key.

On: Turn the key clockwise as far as it will go and release it to the on position.

Off: Turn the key counterclockwise.



HOURMETER

The hourmeter records the number of hours the machine has been in use. Use this information as a guide to indicate when routine maintenance needs to be performed.

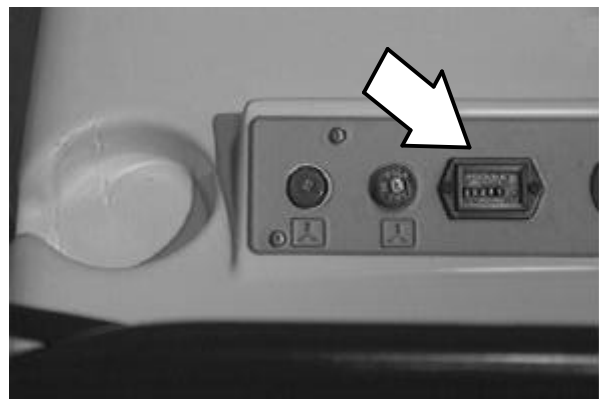

BATTERY DISCHARGE INDICATOR

The battery discharge indicator displays the charge level of the batteries while the machine is operating.

When the batteries are fully charged, the indicator on the far right is lit. As the batteries discharge, the indicator light will move across the display from right to left. The batteries should be recharged when the second indicator from the far left flashes. *When two indicators on the left flash, the machine will gradually slow down, then stop.* Drive, or push the machine in neutral, to the battery charging area and charge the batteries immediately after the battery discharge indicator(s) begin to flash.

NOTE: *The reading on the battery discharge indicator may not be accurate when the machine is first powered on. Operate the machine for a few minutes before reading the charge level of the batteries.*

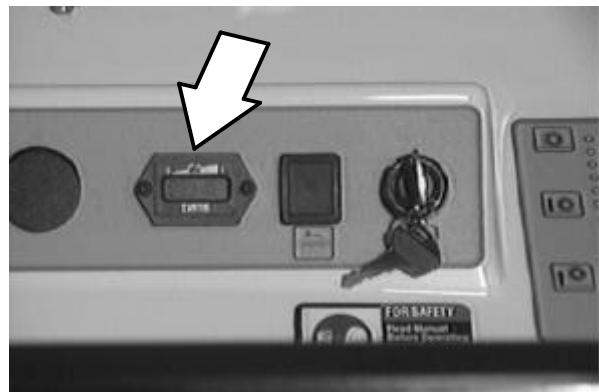

OPERATION

POWER KILL SWITCH (OPTION)

The Power Kill Switch immediately stops all power to the machine.

Stop machine power: Press the Power Kill Switch.

Restart machine power: Release the Power Kill Switch by turning it to the right. Turn the key counter-clockwise, then turn the key fully clockwise and release it to the on position.

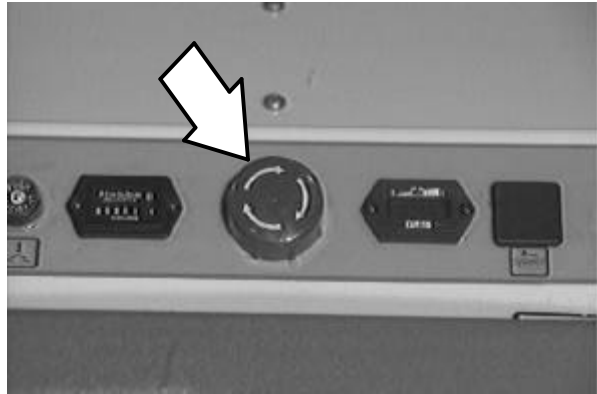

CIRCUIT BREAKERS

Circuit breakers are resettable electrical circuit protection devices designed to stop the flow of current in the event of a circuit overload. Once a circuit breaker is tripped, reset it manually by pressing the reset button after the breaker has cooled down.

If the overload that caused the circuit breaker to trip is still present, the circuit breaker will continue to stop current flow until the problem is corrected.

The circuit breakers are located on the instrument panel.

The chart below shows the circuit breakers and the electrical components they protect.

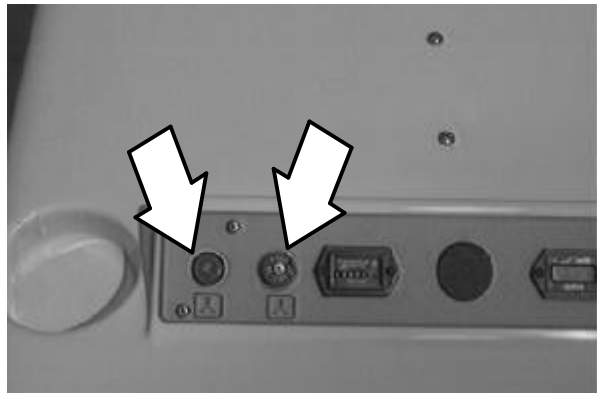

Circuit Breaker	Rating	Circuits Protected
CB1	15 A	Filter shaker motor Side brush motor(s)
CB2	50 A	Main motor, standard,
CB2	40 A	Main motor, (EE)

FILTER SHAKER SWITCH

The filter shaker switch activates the filter shaker motor. The shaker motor shakes debris from the panel filter. Machines with a bag filter do not have a filter shaker motor or switch.

Make sure the filter compartment door is closed properly, then press the switch. The filter shaker motor will shake the filter for 15 seconds, then stop automatically. Remove loose debris from the panel filter compartment door when the shaker motor stops.



THERMO SENTRY™

The Thermo Sentry™ will automatically turn the machine's power off in case of a fire in the hopper. If the Thermo Sentry™ is tripped, reset it by pushing the reset button.

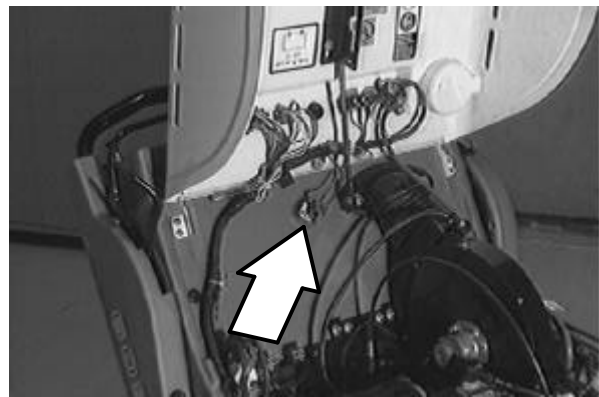

VACUUM WAND (OPTION)

The vacuum wand uses the machine's vacuum system. Use the vacuum wand to pick up debris in narrow or partially enclosed areas that cannot be swept by the machine. Fully insert the vacuum wand into the machine when not in use.



OPERATION

HOW THE MACHINE WORKS

The operator steers the machine by using the steering bar. The directional control lever controls the forward or reverse direction of the machine. The clutch handle engages the propelling system when it is squeezed toward the steering bar. The clutch handle will also stop the machine when it is released.

The side brush sweeps debris into the path of the main brush. The main brush sweeps debris from the floor into the hopper. The vacuum system pulls dust and air through the main brush compartment and the dust filter.

When sweeping is finished, press the filter shaker switch (option) to clean the panel filter (option) if the machine has these options. Clean the panel filter compartment. Empty the hopper.

If the machine has a bag filter, check the filter bag and replace if full. Empty the hopper.

PRE-OPERATION CHECKLIST

- Check controls for proper operation.

- Check the electrolyte level in each battery cell.

- Check maintenance records to determine service requirements.

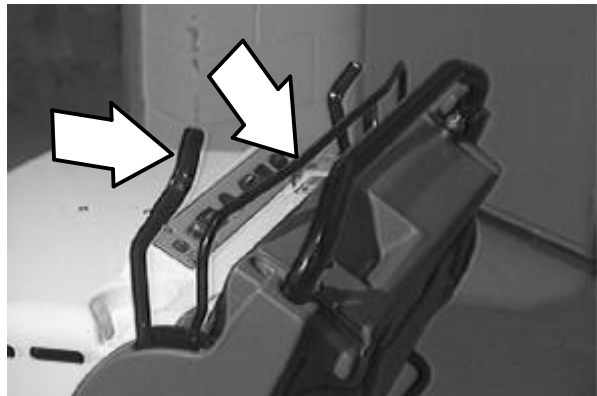

STARTING THE MACHINE

1. Turn the machine power on.



2. Move the directional control lever into the desired forward speed (second, first, or third).

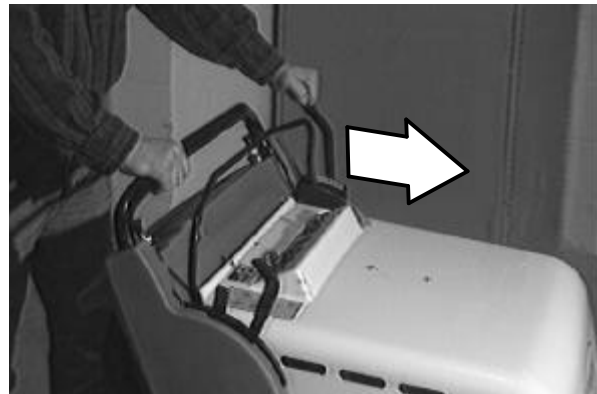

3. Gently squeeze the clutch handle to move the machine forward.

NOTE: The farther the clutch handle is squeezed toward the steering bar, the faster the machine will travel, up to its maximum in the selected position.



4. Drive the machine to the area to be swept.

SWEEPING AND BRUSH INFORMATION

Pick up oversized debris before sweeping. Flatten or remove bulky cartons from aisles before sweeping. Pick up pieces of wire, twine, string, etc., which could become entangled in the brushes or brush plugs.

Plan the sweeping in advance. Try to arrange long runs with minimum stopping and starting. Sweep debris from very narrow aisles into the main aisles ahead of time. Do an entire floor or section at one time. Drive the straightest path possible. Avoid bumping into posts or scraping the sides of the machine. Overlap the sweeping paths.

Polypropylene 8-double row main brush - Superior pick-up of sand, gravel, and paper litter. Polypropylene retains its stiffness when wet and can be used indoors or outdoors with equal performance.

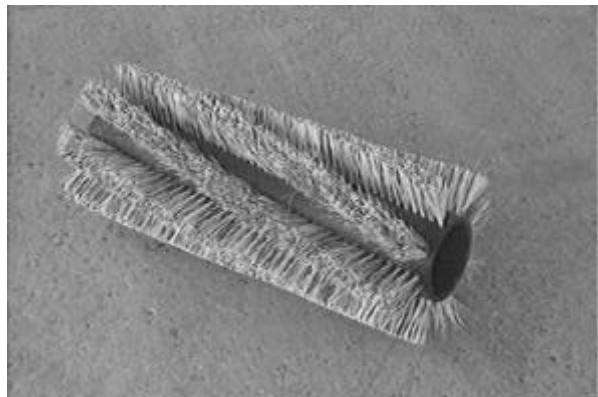

Polypropylene double row main brush for carpet - Soft poly bristles are designed to sweep and raise the tuft, without wear or damage to the carpet.

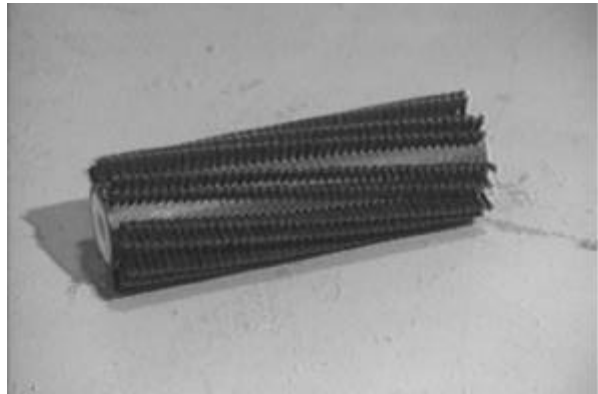

Polypropylene Side Brush - A good general purpose brush for sweeping light to medium debris on floors, carpet, and outdoor surfaces. This brush is recommended when bristles may get wet.



SWEEPING

1. Drive the machine to the area to be swept.
2. Release the clutch handle to stop the machine.
3. Move the main brush lever to the left, out of the raised position, then allow it to fall forward into the sweeping position.

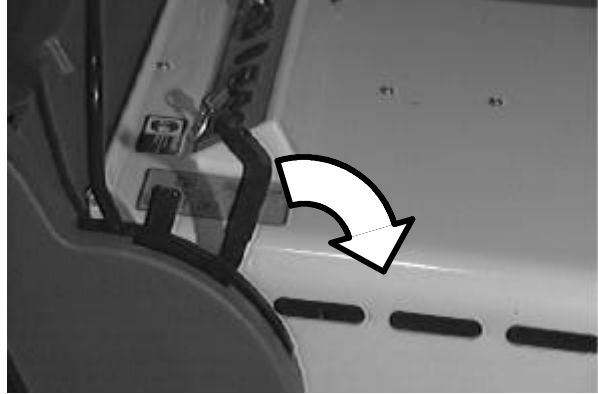

4. Move the side brush lever to the right, out of the raised position, then forward to the desired brush down pressure setting.



5. Squeeze the clutch handle to begin sweeping.



6. Sweep as needed.

OPERATION

SWEEPING CARPET

1. If necessary, remove the floor sweeping brush and install the carpet sweeping brush.

NOTE: DO NOT attempt to sweep carpet with a floor sweeping brush. Damage to the carpet could result.

2. Clean the rear wheels and front casters with a damp cloth before sweeping carpet.
3. Install the carpet sweeping pin into the main brush lever to control carpet brush down pressure. Do not attempt to sweep carpet without first installing the brush down pressure pin.



4. Ensure the battery bags are in place. Do not remove battery bags from machine.

NOTE: The battery bags are designed to prevent an accidental overflow of battery acid from damaging the carpet.

5. If desired, move the side brush lever to the right, out of the raised position, then then forward to the desired brush down pressure setting.

NOTE: Sweeping carpet with the side brush(es) is optional.

6. Move the main brush lever to the left, out of the raised position, then forward to the desired carpet brush down pressure setting.



7. Squeeze the clutch handle to begin sweeping.
8. Sweep as needed.

STOP SWEEPING

1. Release the clutch handle.

NOTE: The machine will immediately slow down, then stop completely.



2. Move the main brush lever backward, then to the right to raise and set the main brush in the raised position.



3. Move the side brush lever backward, then to the left to raise and set the side brush(es) in the raised position.



OPERATION

4. Move the directional control lever into the PARK position.

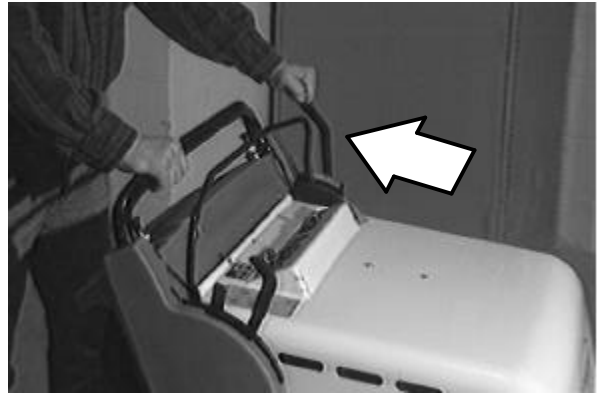

5. Shake the panel filter by pressing the filter shaker switch. The shaker motor will operate for 15 seconds before stopping.

NOTE: Make sure the filter compartment is closed securely before activating filter shaker.

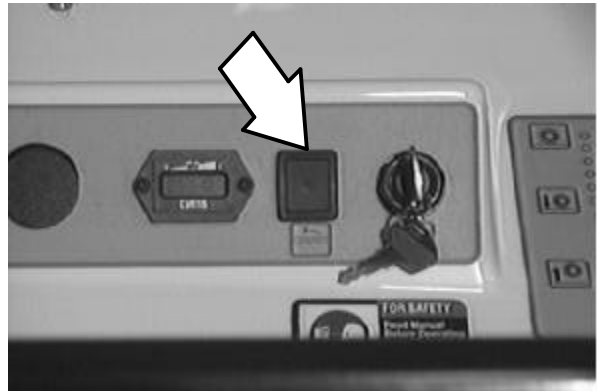

6. Turn the machine power off.



EMPTYING THE DEBRIS HOPPER

STANDARD HOPPER

Drive the machine to the area where debris is collected.

Turn the machine power off.

 **WARNING: Brush throws debris. Stop motor before lifting hopper.**

The debris hopper is equipped with one center, and two side finger grips to allow two people to lift and empty the hopper.

Pull the hopper slightly forward to unseat it from the machine frame.



With one person on each side, lift the debris hopper out of the machine.

NOTE: Do not attempt to lift the hopper when it is full of debris without assistance. Dump the debris from the hopper into a pile on the floor near a trash can or dumpster, then pick the debris up with a shovel.

 **WARNING: Heavy hopper. Get help to handle.**

OPERATION

HOPPER DUMP ASSIST HANDLE (OPTION)

The dump assist handle allows easy removal and transport of the debris hopper when it is full.

Turn the machine power off.

 **WARNING: Brush throws debris. Stop motor before lifting hopper.**

Raise the dump assist handle.



Place one foot on the hopper's pivot point.



Lift the hopper out of the machine and onto the wheels. Transport the hopper to the location where debris is collected.

 **WARNING: Heavy hopper. Get help to handle.**

NOTE: Do not attempt to lift the hopper when it is full of debris without assistance. Dump the debris from the hopper into a pile on the floor near a trash can or dumpster, then pick the debris up with a shovel.



REPLACING THE BAG FILTER (OPTION)

The bag filter (option) traps dust and small particles of debris. Check the bag filter daily and replace it when it becomes full of debris.



To access the bag filter, remove the vacuum wand and unlatch the filter compartment hooks.

Install a new bag filter by placing the cardboard tab on the filter around the vacuum inlet tube.



The vacuum inlet tube is located at the top of filter compartment, on the inside of the machine.



Latch the filter compartment door. Fully insert the vacuum wand into the machine.

OPERATION

CLEANING THE FILTER COMPARTMENT

The panel filter traps dust and small particles of debris. Press the filter shaker switch to shake the debris from the panel filter each time the hopper is emptied. This debris collects in the filter compartment. Clean the filter compartment daily.

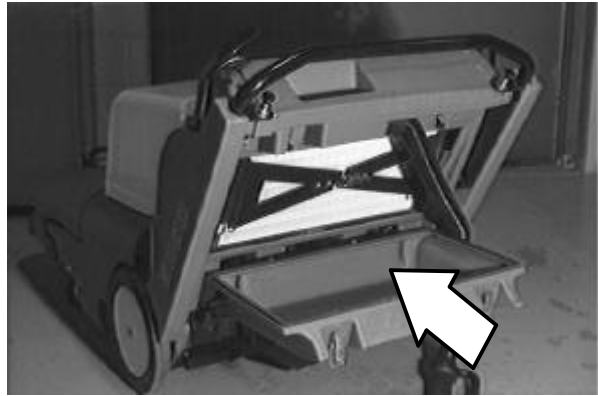

Remove the vacuum wand and unlatch the filter compartment hooks.

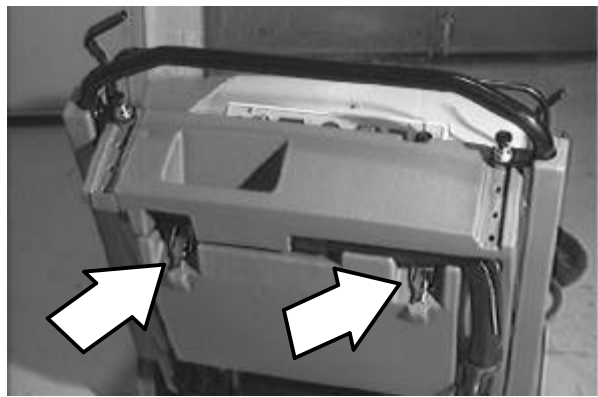

Lower and remove the filter compartment door by sliding it to the left off the pivot pins. Empty the dust and debris.

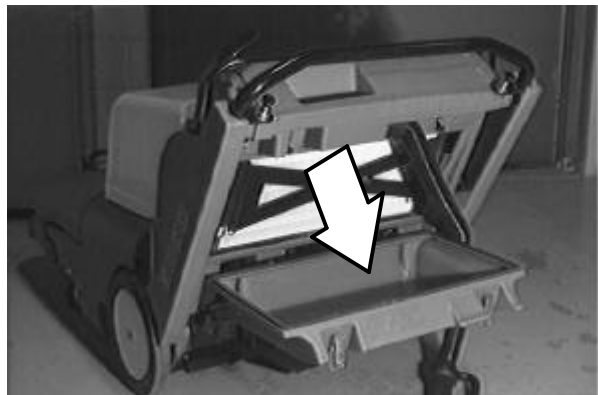

Replace and latch the filter compartment door. Fully insert the vacuum wand into the machine.

POST-OPERATION CHECKLIST

Check this list of items after sweeping and emptying hopper:

- Check for wire or string tangled in the bristles of the main brush and side brush(es). Additional side brush (option) shown.

FOR SAFETY: Before leaving or servicing machine, stop on level surface, turn off machine, and remove key.



- Check and, if necessary, wipe the vacuum inlet plate clean.
- Check the skirts and seals for damage and wear.
- Check the electrolyte levels in the battery cells after charging.
- Check the bag filter (option) for fullness or shake the panel filter and clean the filter compartment.
- Check the service records to determine routine maintenance requirements.



OPERATION ON INCLINES

When operating the machine on an incline, use first speed for increased power and control. The maximum rated climb and descent angle for the machine is 8°.

NOTE: To stop the machine at any time, regardless of direction of travel, release the clutch handle. The machine will immediately slow down, then stop completely.

OPTIONS

WIDE TRACK TIRES AND HEAVY DUTY CASTERS

Wide track tires and heavy duty casters provide increased maneuverability and control on rough surfaces.



MACHINE TROUBLESHOOTING

Problem	Cause	Remedy
Excessive dusting	Vacuum hose clogged	Unscrew hose from vac wand handle and clean
	Brush skirts and dust seals worn or damaged	Replace brush skirts or dust seals
	Filter bag full or panel filter clogged	Shake and / or clean or replace bag or panel filter
	Vacuum wand hose damaged	Replace vacuum wand hose
	Vacuum wand not fully inserted into machine	Insert fully
	Vacuum inlet plate clogged	Remove / clean plate. Clean chamber if necessary
	Vacuum fan failure	Contact Tennant service personnel
Poor sweeping performance	Brush bristles worn	Replace brushes
	Batteries low	Recharge
	Main brush not touching floor	Check brush linkage for binding or contact Tennant service personnel
	Main brush not touching carpet	Adjust main brush down pressure
	Debris caught in main brush drive mechanism	Remove debris from drive mechanism
	Main brush drive failure	Contact Tennant service personnel
	Side brush drive failure	Contact Tennant service personnel
	Hopper full	Empty hopper
	Hopper / brush skirts worn or damaged	Replace skirts
	Wrong sweeping brush	Use yellow / black brush w/ 75 mm (3 in) dia tube for floor sweeping Use black brush w/ 125 mm (5 in) dia tube for carpet sweeping
	Rear skirt damaged	Replace skirt
Machine will not propel or shift	Transmission will not go into gear	Contact Tennant service personnel
	Clutch arm not pulling belt tight enough	Adjust clutch cable length
	Propel belt stop bar not adjusted properly	Contact Tennant service personnel
Machine will not start	Thermo Sentry™ tripped	Reset Thermo Sentry™
	Batteries not properly reconnected after charging	Connect properly
	Batteries discharged	Charge
	Battery disconnect button pushed in	Turn to the right to reset

MAINTENANCE

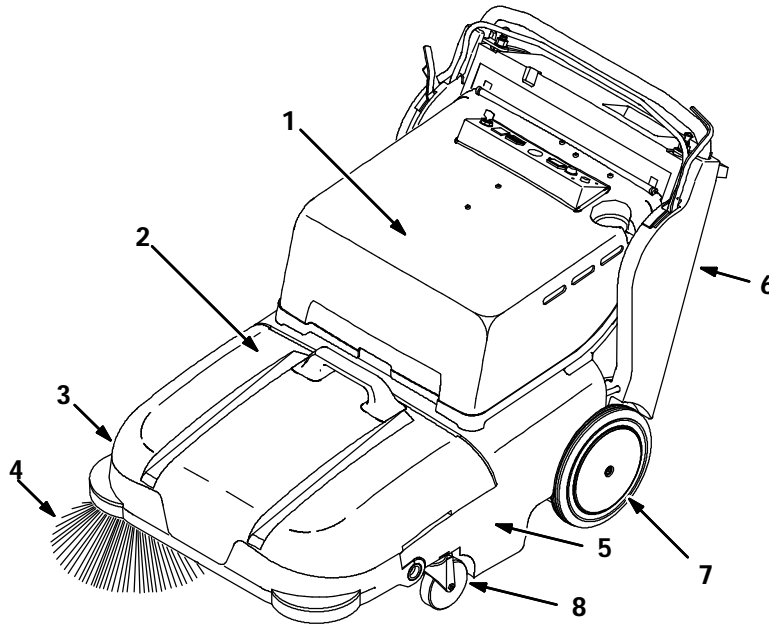

350842

MAINTENANCE CHART

Interval	Key	Description	Procedure	Lubricant/ Fluid	No. of Service Points
Daily	1	Battery cells	Check electrolyte level after charging	DW	2
	4,5	Main brush and side brush(es)	Check for damage and wear	-	2 (3)
	2	Vacuum inlet plate	Check / clean	-	1
	2	Skirts and seals	Inspect	-	6
	6	Bag filter (option)	Check / Replace if full	-	1
	6	Panel filter	Shake filter, clean compartment door	-	1
50 Hours	1	Vacuum fan belt	Check tension and wear	-	1
	5	Main brush	Rotate end for end and check brush pattern	-	1
	1	Battery cells	Check electrolyte level	DW	3
100 Hours	6	Panel filter	Remove and clean	-	1
	7	Wide track tires (option)	Check for damage / pressure	-	2
	8	Heavy duty casters (option)	Lubricate	SPL	2
200 Hours	1	Battery terminals	Clean and tighten	-	4
500 Hours	3	Side brush motor(s)	Check motor brush	-	1 (2)
1000 Hours	1	Main motor	Check motor brush	-	1

LUBRICANT/FLUID

DW . . . Distilled water

SPL . . . Special lubricant, Lubriplate EMB grease (TENNANT part no. 01433-1)

BATTERIES

The batteries are designed to hold their power for long periods of time. The lifetime of the batteries is limited to number of charges the batteries receive. To get the most life from the batteries, recharge them immediately when the battery discharge indicator begins to blink.

Every 200 hours of operation, check for loose battery connections and clean the surface of the batteries, including terminals and cable clamps, using a strong solution of baking soda and water. Brush the solution sparingly over the battery tops. Do not allow any baking soda solution to enter the batteries. Use a wire brush to clean the terminal posts and the cable connectors. Wipe off all cleaning solution residue. After cleaning, apply a coating of clear battery post protectant to the terminals and the cable connectors. Keep the tops of the batteries clean and dry.

Objects made of metal can potentially short circuit the batteries. Keep all metallic objects off the batteries. Replace any worn or damaged wires.

Check the electrolyte level in each battery cell after charging and after every 50 hours of operation. Never add acid to the batteries. Add distilled water *only*. Always keep the battery caps on, except when adding water or taking hydrometer readings.



Using a hydrometer, measure the specific gravity to determine the charge level and condition of the batteries. If one or more of the battery cells test lower than the other battery cells (0.050 or more), the cell is damaged, shorted, or is near failure. Completely recharge the batteries, then retest them.

NOTE: Do not take readings immediately after adding distilled water. If the water and acid are not thoroughly mixed, the readings may not be accurate. Check the hydrometer readings against the following chart to determine the remaining battery charge level:

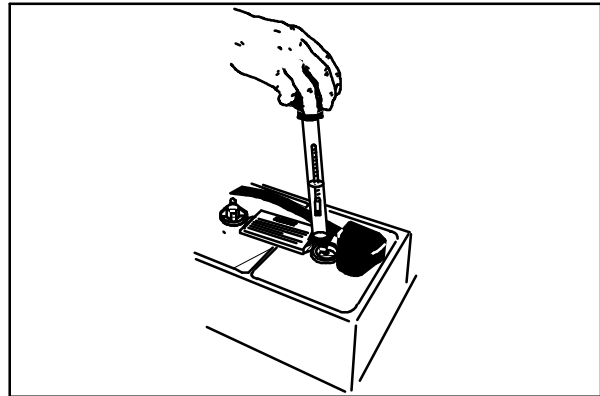

04380

SPECIFIC GRAVITY at 27° C (80° F)	BATTERY CHARGE
1.280	100% Charged
1.230	75% Charged
1.190	50% Charged
1.150	25% Charged
1.110	Discharged

CHARGING THE BATTERIES

1. Drive the machine to a flat, dry surface.

NOTE: Make sure the area is well ventilated.

2. Turn the machine power off.

FOR SAFETY: Before leaving or servicing machine, stop on level surface, turn off machine, and remove key.

3. Move the directional control lever into the PARK position.
4. Lift the battery compartment cover to access the batteries. The support arm automatically engages when the cover is lifted all the way up.

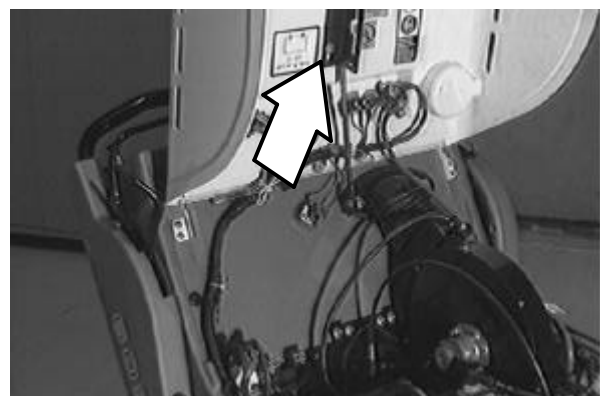

MAINTENANCE

5. Check the water level in all battery cells. If the level is low, add just enough distilled water to cover the plates. **DO NOT OVERFILL.** The batteries can overflow during charging due to expansion.

NOTE: Make sure the battery caps are in place while charging.

FOR SAFETY: When maintaining or servicing machine, avoid contact with battery acid.

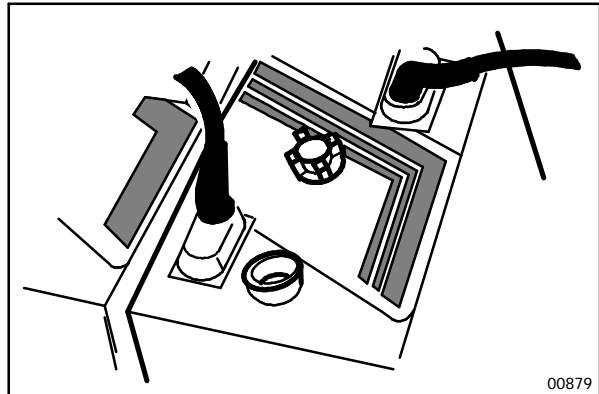

6. Unplug the machine connector from the batteries.



7. Plug the charger connector into the battery connector.

⚠ WARNING: Batteries emit hydrogen gas. Explosion or fire can result. Keep sparks and open flame away. Keep covers open when charging.



8. Plug the battery charger into the wall outlet.

NOTE: If the red "ABNORMAL CYCLE" lamp lights when the TENNANT charger is plugged into a wall outlet, the charger cannot charge the battery and there is something wrong with the battery.

9. The TENNANT charger will start automatically. When the batteries are fully charged, the TENNANT charger will automatically turn off.
10. After the charger has turned off, unplug the charger from the wall outlet.

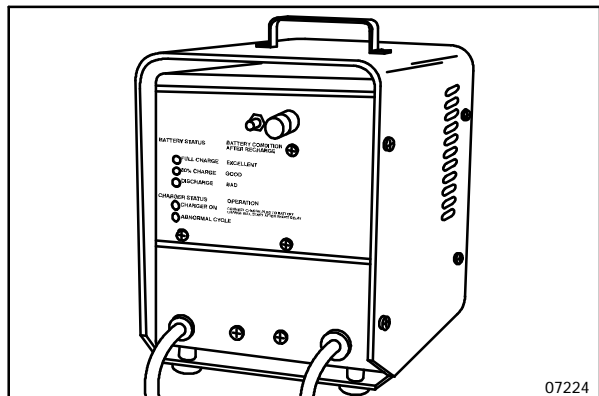

11. Unplug the charger connector from the battery connector on the machine.

FOR SAFETY: When maintaining or servicing machine, avoid contact with battery acid.



12. Connect the machine connector to the battery connector.
13. Lower the battery compartment cover by slightly raising it while pushing the support arm inward.

LUBRICATION

HEAVY DUTY CASTERS (OPTION)

The heavy duty casters (option) each have one grease fitting on the caster swivel. Lubricate each caster with a grease gun containing Lubriplate EMB grease (Tennant part no. 01433-1) after every 100 hours of operation.

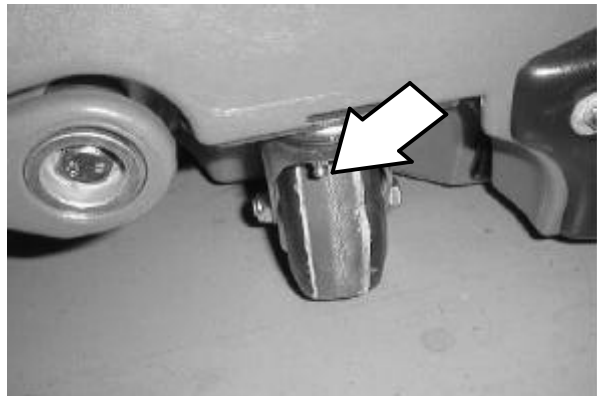

SKIRTS AND SEALS

MAIN BRUSH SKIRTS

The main brush skirts are located at the ends of the main brush. These skirts are designed to deflect debris into the hopper.

Check the brush skirts for damage or wear daily.

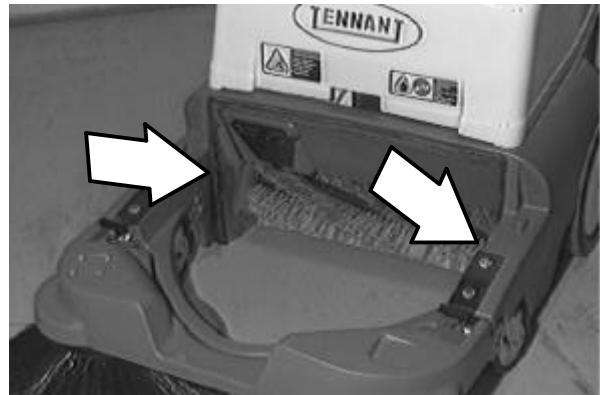

HOPPER DUST SEAL

The hopper dust seal, located at the top of the hopper compartment, helps maintain a vacuum within the hopper.

Check the hopper dust seal for damage or wear daily.



REAR SKIRT

The rear skirt, located behind the main brush, helps create a vacuum around the main brush.

Check the rear skirt for damage or wear daily.



HOPPER LIP SKIRT

The hopper lip skirt, located on the lip of the hopper, ensures debris thrown from the main brush will go into the hopper.

Check the hopper lip skirt for damage or wear daily.

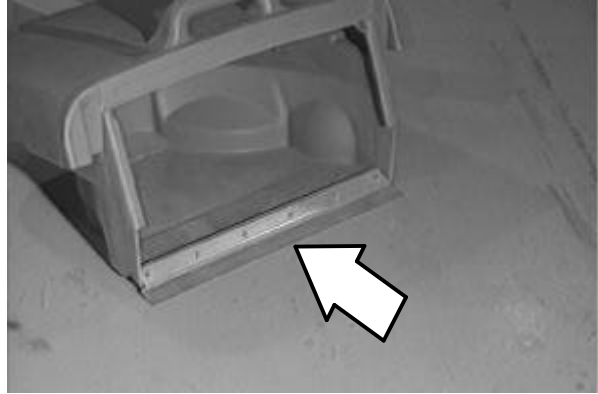
**FILTER COMPARTMENT DOOR SEAL**

The filter door seal, located around the perimeter of the filter compartment door, helps maintain a vacuum around the filter.

Check the filter compartment door seal for damage or wear daily.

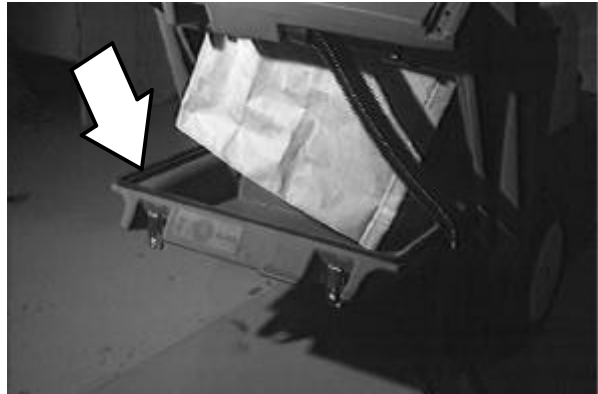

VACUUM INLET PLATE

The vacuum inlet plate is located on the left-hand side of the hopper compartment. The vacuum inlet plate prevents large pieces of debris from entering the vacuum chamber.

Check the vacuum inlet plate daily. If necessary remove and wipe it clean with a damp cloth.



CLEANING THE PANEL FILTER

The panel filter filters the air pulled up from the hopper. The panel filter is equipped with a shaker to remove the accumulated dust particles. Remove and thoroughly clean the panel filter after every 100 hours of use.

To remove the panel filter, unlatch and lower the filter compartment door.

Unlatch the panel filter retainer and remove the filter.

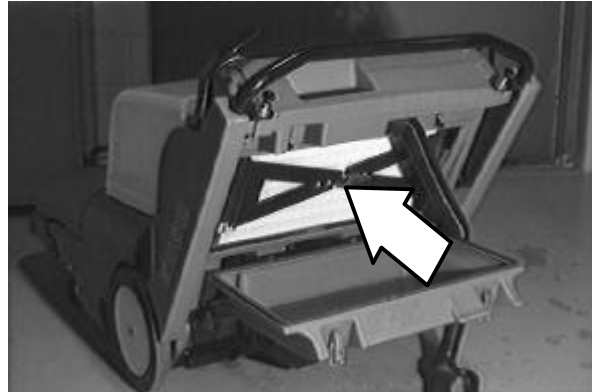

To clean the panel filter, use one of the following methods:

- **TAPPING** - Tap the filter gently on a flat surface with the dirty side down. Do not damage the edges of the filter element, or the filter will not seat properly in the filter compartment.
- **AIR** - Blow air through the filter from the opposite side of the fingertabs. Always wear eye protection when using compressed air.

FOR SAFETY: When servicing machine, wear eye and ear protection if using pressurized air or water.

- **WATER** - Soak the filter in a water and mild detergent solution. Rinse the filter until it is clean. Air dry the filter; do not use compressed air.

NOTE: Be sure the dust filter is completely dry before reinstalling it in the machine.

BRUSHES

MAIN BRUSH

NOTE: The following procedures apply to both the floor sweeping main brush and the carpet sweeping main brush.

The main brush spans the width of the machine and throws debris into the hopper.

Check the brush for damage and wear daily. Remove string or wire tangled in the main brush or the main brush hub.

Check the main brush pattern after every 50 hours of use. Adjust the main brush pattern by loosening the nut at the left end of the brush arm crossbar.

Rotate the main brush after every 50 hours of use for maximum brush life and sweeping performance.

Replace floor or carpet sweeping brush when bristle length is 9 to 12 mm (.375 to .5 in).

REPLACING THE MAIN BRUSH

1. Turn the machine power off and move the directional lever into the PARK position.

FOR SAFETY: Before leaving or servicing machine, stop on level surface, turn off machine, and remove key.

2. The main brush pin, located on the left-hand side of the machine, holds the main brush in place. Turn the main brush pin 1/4 turn counter-clockwise and remove. If the machine has the (option) wide track wheel kit, lower the main brush to remove.



MAINTENANCE

3. Remove the debris hopper.
4. Pull the string guard and skirt back to avoid damaging.



5. Pull the main brush out of the machine through the hopper opening.



6. Remove the brush hub from the worn brush and install it into the new brush.

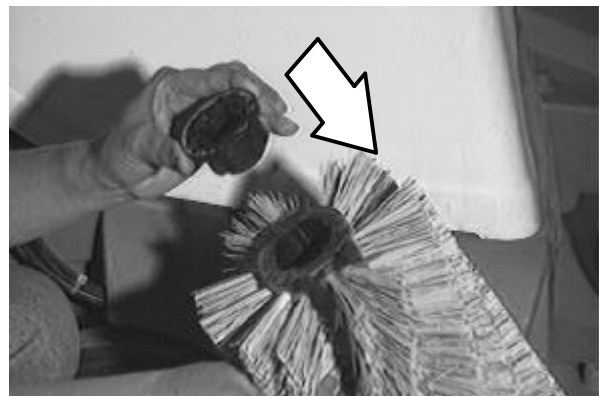

7. Install the new main brush into the machine.
8. Insert the main brush pin through the hole in the frame and into the main brush hub. Turn the main brush pin 1/4 turn clockwise.
9. Replace the hopper.

CHECKING AND ADJUSTING MAIN BRUSH PATTERN

1. Apply chalk (or another material that will not easily blow away), to a smooth, level section of the floor.
2. Lower the main brush in the chalked area. Allow the machine to sweep in the same place for 15 to 20 seconds.

NOTE: If chalk or other material is not available, allow the brush to spin on the floor for two minutes. A polish mark will remain on the floor.

3. Raise the main brush and move the machine away from the chalked area. Turn the machine power off.
4. Observe the shape of the brush pattern. If the brush pattern has parallel sides, the brush does not need adjustment.

If the brush pattern is tapered, the main brush needs adjustment to straighten the brush pattern.

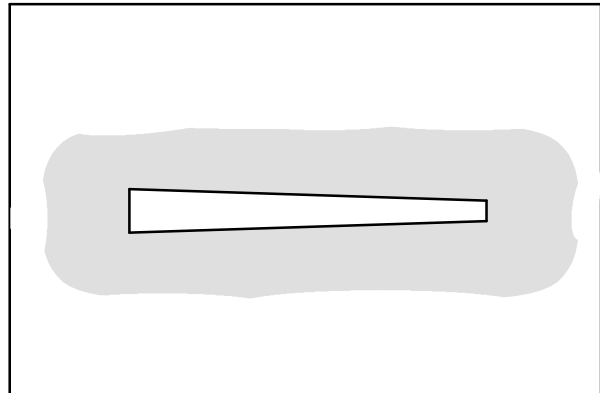

00601

- A. To adjust brush taper, loosen the nut at the left end of the brush arm crossbar. Move the crossbar up or down in the slide relative to the adjustment on the other side. Tighten the nut.
- B. Check the brush again pattern and readjust if necessary.



MAINTENANCE

ROTATING THE MAIN BRUSH

1. Turn the machine power off and move the directional lever into the PARK position.

FOR SAFETY: Before leaving or servicing machine, stop on level surface, turn off machine, and remove key.

2. Turn the main brush pin 1/4 turn counter-clockwise and remove.
3. Remove the debris hopper.
4. Pull the main brush out of the machine through the hopper opening.
5. Remove the brush hub from the main brush and install it into the other end.
6. Install the main brush into the machine.
7. Insert the main brush pin through the hole in the frame and into the main brush hub. Turn the main brush pin 1/4 turn clockwise.



8. Replace the hopper.

SIDE BRUSH(ES)

The side brush(es) sweep debris along walls and edges into the path of the main brush.

Check the side brush(es) for damage and wear daily. Remove string or wire tangled in the side brush(es).

A side brush should be replaced when it no longer effectively sweeps for your application.

REPLACING THE SIDE BRUSH(ES)

1. Turn the machine power off and move the directional lever into the PARK position.

FOR SAFETY: Before leaving or servicing machine, stop on level surface, turn off machine, and remove key.

2. Reach underneath the side brush and remove the cotter pin that holds it on the drive shaft.

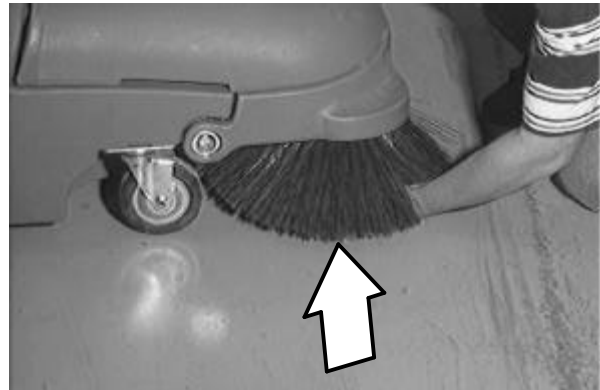

3. Remove the worn brush.
4. Place a new side brush onto the drive shaft and secure with the cotter pin.

ELECTRIC MOTORS

Check the side brush motor brushes every 500 hours of operation. Replace the motor brushes when they are worn 9 mm (.375 in).

Check the main motor brushes every 1000 hours of operation. Replace the motor brushes when they are worn 9 mm (.375 in).

BELTS AND CHAINS

VACUUM FAN BELT

The vacuum fan belt drives the vacuum system. Check the belt for wear and tension after every 50 hours of operation.

Check belt tension by applying a force 1 kg (2 lb) at belt midpoint. The proper deflection should be 5 mm (0.09 in).

 **WARNING: Moving belt and fan. Keep away.**

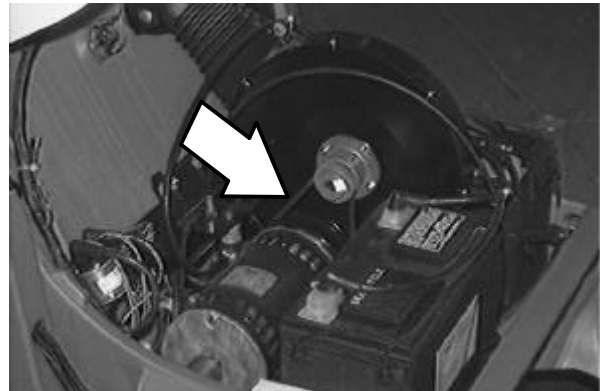

MAIN BRUSH BELT

The main brush drive belt is located behind the right rear tire. The belt drives the main brush. The proper belt tension is automatically set by a spring-loaded idler.

STATIC DRAG CHAIN

The static drag chain prevents the buildup of static electricity in the machine. The chain is attached to the backstop bracket.

Make sure the chain is always touching the floor.



CLUTCH CABLE

The clutch handle engages the machine's propelling system. The clutch handle is connected to the clutch cable. The clutch cable may stretch over time and require adjustment.

Adjust cable length by turning the nut at the base of the clutch cable.



TIRES (OPTION)

The heavy duty rear tires are pneumatic.

Check the rear tires after every 100 hours of operation for damage. Check the rear tire pressure after every 100 hours of operation. The proper tire pressure is 345 kPa (50 psi).

PUSHING AND TRANSPORTING THE MACHINE

The machine can be pushed in neutral if necessary.

Tilt trailer or lower the tailgate so the machine can be driven on to it. Position the machine so it rests against the front of the trailer. Secure the machine toward the front of the trailer by wrapping a strap around the filter compartment and hooking the ends near the front corners of the machine. Secure the machine down by wrapping a strap across the battery compartment and hooking the ends at the sides of the machine. Place small pads or cushions under the straps to prevent machine damage. Make sure the directional control lever is in the park position. Block the tires to keep the machine from rolling during transport.

STORING MACHINE

When storing the machine for extended periods of time, the following procedures must be followed:

1. Raise the main and side brush(es).
2. Empty and clean the debris hopper.
3. Fully charge the batteries.
4. Disconnect the machine connector from the battery connector.
5. Store the machine in a clean dry area.

SPECIFICATIONS

SPECIFICATIONS

GENERAL MACHINE DIMENSIONS/CAPACITIES

Item	Dimension/capacity
Length (Low / High steering bar position)	1428 / 1475 mm (56.25 / 58 in)
Width	820 mm (32.25 in)
Height (Low / High steering bar position)	881 / 960 mm (34.7 / 37.7 in)
GVWR - 130 AH batteries	235 kg (520 lb)
GVWR - 215 AH batteries	281 kg (620 lb)
Track	775 mm (30.50 in)
Wheelbase	492 mm (19.36 in)
Main brush diameter	203 mm (8 in)
Main brush length	610 mm (24 in)
Side brush diameter	420 mm (16.5 in)
Sweeping path width, main brush only	610 mm (24 in)
Sweeping path width, main brush and one side brush	815 mm (32 in)
Sweeping path width, main brush and two side brushes	1016 mm (40 in)
Hopper capacity - Maximum	85 L (3.0 cu ft)
Hopper capacity - Usable	42.5 L (1.5 cu ft)
Panel filter area	3.62 sq m (39 sq ft)
Bag filter volume	17 L (0.6 cu ft)

GENERAL MACHINE PERFORMANCE

Item	Measure
Maximum forward speed - first speed	1.3 kmh (0.8 mph)
Maximum forward speed - second speed	2.6 kmh (1.6 mph)
Maximum forward speed - third speed	4.5 kmh (2.8 mph)
Maximum reverse speed	2.1 kmh (1.3 mph)
Minimum steering diameter	1588 mm (62.5 in)
Minimum turning radius	794 mm (31.25 in)
Maximum rated climb and descent angle	8°
Battery run time - 130 Amp / hr	2.0 - 3.0 hr
Battery run time - 215 Amp / hr	4.0 - 5.0 hr

POWER TYPE

Type	Quantity	Volts	Ah Rating	Weight
Batteries	2	12	130 @ 20 hr rate	30 kg (67 lb)
	2	12	215 @ 20 hr rate	55 kg (122 lb)

Type	Use	VDC / Amp	Kw (hp)
Electric Motors	Side brush(es) (disk)	24 V / 2.4 A	0.075 kw (0.1 hp)
	Main motor	24 V / 43 A	0.75 kw (1 hp)

Type	VDC	Amp	Hz	Phase	VAC
Charger (Smart)	24	15 or 20	50 / 60	1	120 /240

TIRES

Location	Type	Size
Front (2)	Casters	35 mm wide x 127 mm OD (1.375 in wide x 5 in OD)
Rear (2)	Solid	45 mm wide x 305 mm OD (1.75 in wide x 12 in OD)

SPECIFICATIONS

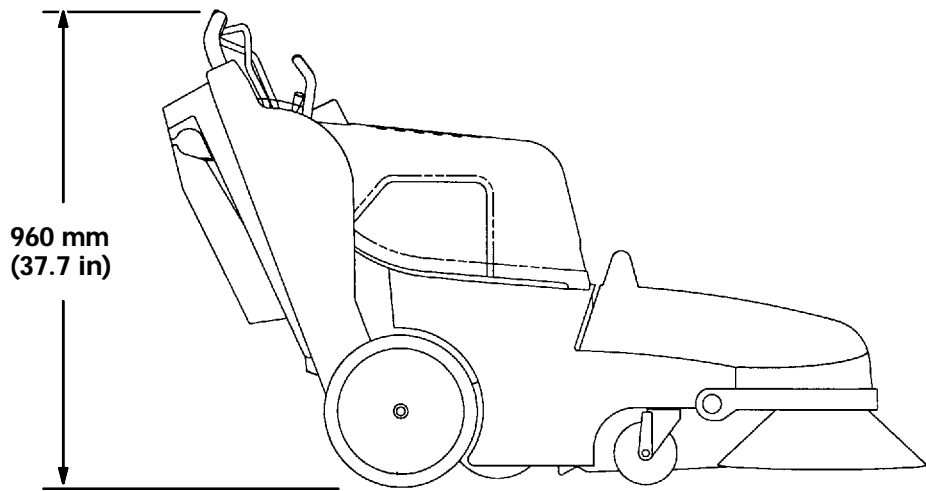
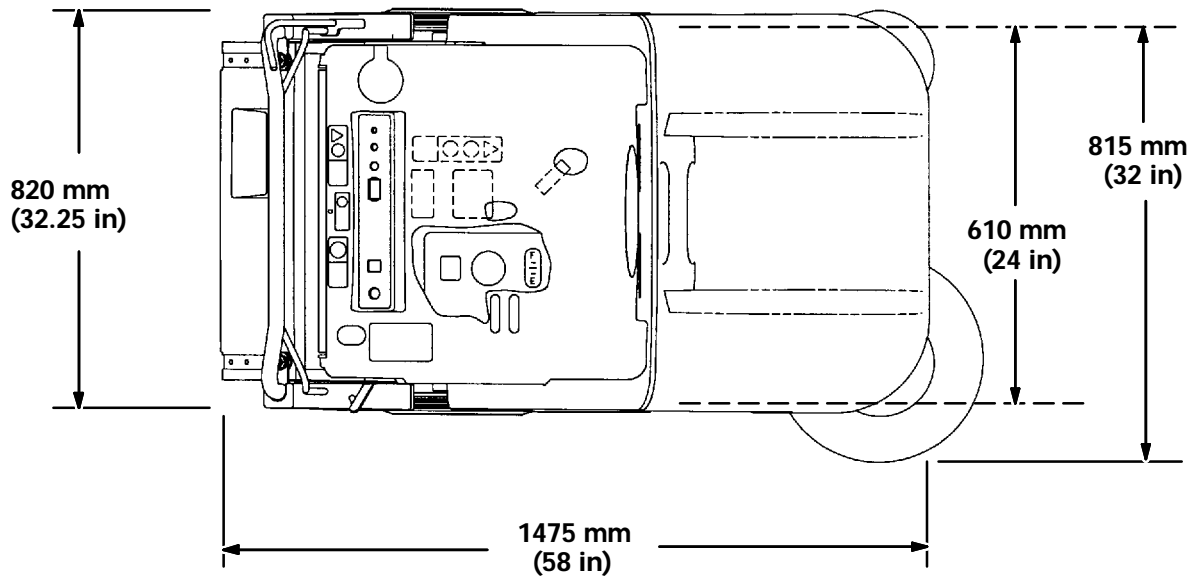

MACHINE DIMENSIONS

350910

INDEX

B

- Bag filter replacement, 25
- Batteries
 - Charging the batteries, 33
 - General information, 32
 - Maintenance, 32
 - Measuring specific gravity, 33
 - Run time, 46
- Battery bags (option), 20
- Battery discharge indicator, 13
- Battery disconnect button (option), 14
- Belts
 - Main brush, 44
 - Vacuum fan, 44
- Braking, stopping machine, 11
- Brush information, 18
- Brushes
 - Main brush, 39
 - Main brush pattern, checking, adjusting, 41
 - Main brush, rotation, 42
 - Replacing main brush, 39
 - Replacing side brush(es), 43
 - Side brush(es), 43

C

- Cable, clutch, 44
- Carpet sweeping, 20
- Carpet sweeping kit (option)
 - Battery bags, 20
 - Brush down pressure pin, 20
 - Carpet brush, 18
- Chain, static drag, 44
- Circuit breakers, 14
- Clutch cable, 44
- Clutch handle, 11
- Controls
 - Battery disconnect button (option), 14
 - Clutch handle, 11
 - Directional control lever, 9
 - Key switch, 13
 - Main brush lever, 11
 - Side brush lever, 12
 - Steering bar, 12
 - Steering bar adjustment knobs, 12
- Controls and Instruments, 8

D

- Directional control lever, 9

E

- Electric motors, 43
- Electrical system
 - Batteries, 32
 - Charging the batteries, 33
 - Circuit breakers, 14

F

- Filter compartment, panel, Cleaning, 26
- Filter shaker switch, 15
- Filters
 - Bag filter replacement, 25
 - Panel filter cleaning, 38

H

- Hopper
 - Dump assist handle emptying (option), 24
 - Standard hopper emptying, 23
- Hourmeter, 13

I

- Indicators, Battery discharge indicator, 13
- Instruments, Hourmeter, 13

K

- Key switch, 13

L

- Levers
 - Directional control lever, 9
 - Main brush lever, 11
 - Side brush lever, 12
- Lubrication, heavy duty casters (option), 35

M

Machine
 Pushing, transporting, 45
 Storage, 45
Machine components, 6
Machine dimensions, 48
Machine troubleshooting, 29
Main brush, 39
 Checking and adjusting brush pattern, 41–43
 Replacement, 39
 Rotation, 42–44
Main brush lever, 11
Maintenance, Recommended, 5
Maintenance chart, 31
Motors, electric, 43

O

Operation
 How the machine works, 16
 Post-operation checklist, 27
 Pre-operation checklist, 16
 Starting the machine, 17
 Stop sweeping, 21
 Stopping the machine, 11
 Sweeping and brush information, 18
 Sweeping carpet, 20
 Sweeping floors, 19
 Sweeping on inclines, 27
Operation of controls, 9
Operator responsibility, 5
Options
 Battery disconnect button, 14
 Hopper dump assist handle, 24
 Wide track tires and casters, 28

P

Panel filter, Cleaning, 38
Panel filter compartment, Cleaning, 26
Plate, vacuum inlet, 37

S

Safety
 Labels, 4
 Precautions, 3–5
Side brush lever, 12
Side brush(es), 43–45
Side brush(es) replacement, 43–45
Skirts and seals
 Filter compartment door seal, 37
 Hopper dust seal, 36
 Hopper lip skirt, 37
 Main brush skirts, 36
 Rear skirt, 36
Specifications
 Batteries, 47
 Battery charger, smart, 47
 Battery run time, 46
 Climb and descent angles, maximum, 46
 Electric motors, 47
 Machine capacities, 46
 Machine dimensions, 46
 Machine performance, 46
 Tires, 47
 Traveling speeds, 46
 Turning radius, 46
Steering bar, 12
Steering bar adjustment knobs, 12
Storing machine, 45
Sweeping
 Carpet, 20
 Floors, 19
Sweeping and brush information, 18
Switches
 Filter shaker switch, 15
 Key switch, 13
Symbols, definitions, 7

T

Thermo Sentry, 15
Tires, 45
 Specifications, 47
Troubleshooting chart, 29

V

Vacuum inlet plate, 37
Vacuum wand, 15